

Compact inverter

FRENIC-Mini Series

COMPACT
INVERTER
FRENIC
Mini

**FUJI ELECTRIC
INVERTERS**

High Performance
Compact Body
Welcome to the
NEXT Generation
of Compact Inverters

New

Compact



And

High
Performance



NEXT Generation!



**High Performance
and
Multipurpose**

**Fully Compatible
with
Existing Products**

**Easy Operation
and
Maintenance**

New Compact Inverter

High Performance Compact Body.
Get Our Most User-Friendly Inverter yet!



NEXT Generation!
**COMPACT
INVERTER**
FRENIC
Mini

FUJI ELECTRIC INVERTERS
High Performance Compact Body.
Welcome to the NEXT Generation of Compact Inverter

With its functionality, compact design, simple operation, and global compatibility, the new FRENIC-Mini elevates the performance of a wide range of devices and equipment--including conveyors, fans, pumps, centrifugal separators, and food processing machines--to give you the system integration, energy efficiency, reduced labor, and lower overall costs you're looking for.

**Energy
Efficient**

**Network
Capabilities**

**Global
Compatibility**



High Performance and Multipurpose

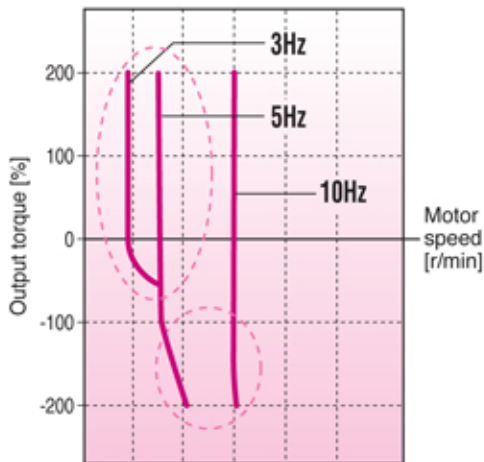

● Dynamic Torque Vector Control System

Fuji Electric original dynamic torque vector control system is known for its top-of-the line performance, delivering stable torque output even at low speeds. This feature has a wide range of applications, including conveyors and high-inertia loads that demand high starting torque.

● Slip Compensation shortens setting time

The slip compensation controller works with voltage tuning for even more accurate speed control at low velocity. This reduces speed control variability and stabilizing creep speed for more accurate stopping in conveyors and similar equipment.

● Fastest CPU Processor in its Class

Advanced CPU processes data at twice the speed of our current model



Full Compatibility and User Friendly Design

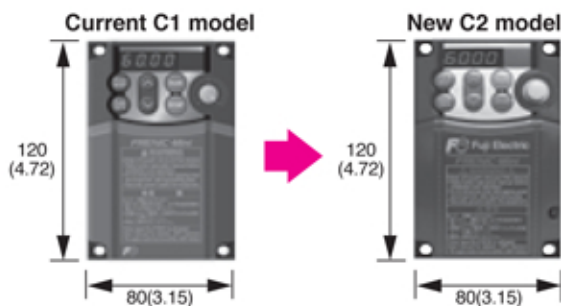

Note: Three-phase 200V 0.1–0.75kW dimensions shown (mm(inch))

External dimensions	Interchangeable
Installed dimensions	Interchangeable
Number of terminals	Same for both main circuit and controllers
Terminal position	Compatible terminal wire length
Function codes	Compatible function codes
RS-485 communication	Shared communications protocol



Easy Operation and Maintenance

● Usability

Delivers all the usability of the C1. Provides volume of frequency and the same ease of operation as the current model.



● USB Keypad

Optional USB keypad available. Enhanced PC loader software (FRENIC Loader) connectivity.

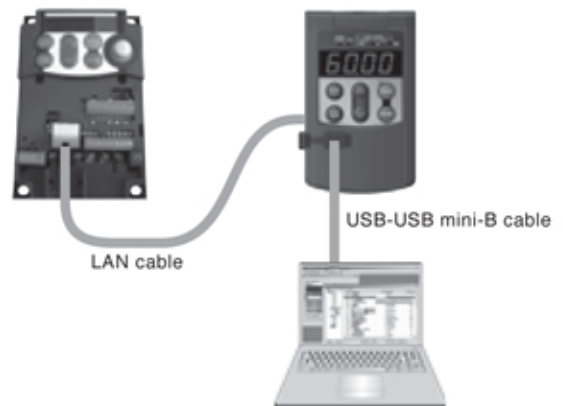

● Improve Maintainability

Function	Description
Mock malfunction	Select a function to set off a mock alarm
Number of startups	Count the total number of ON/OFF run cycles
Cumulative motor running time	Monitor motor run time
Total power	Set to measure total power consumption
Trip history	Saves and displays information on up to four past trips

· FRENIC Loader available as a free download



Energy Optimization

● Optimum Energy Control

Motor tuning minimizes power loss

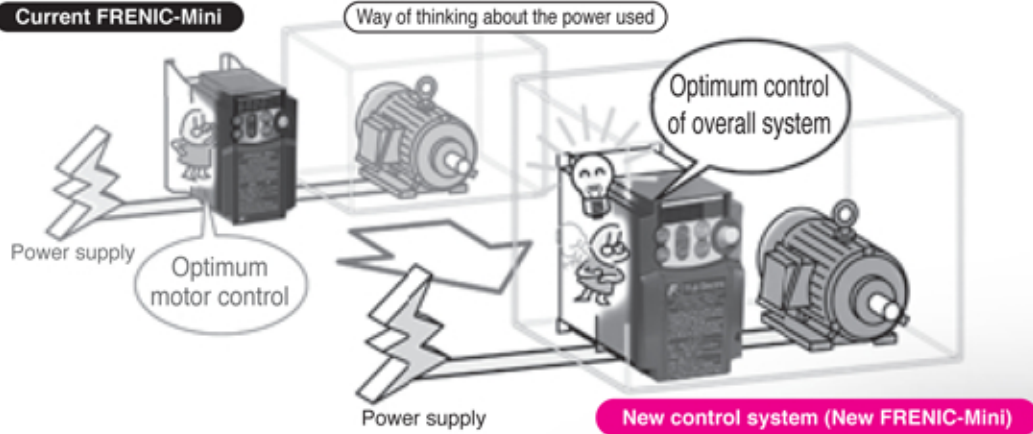

● PID Control Function

Permits motor operation while controlling temperature, pressure, and flow rate without the use of a temperature controller or other external device

● Cooling Fan ON/OFF Control Function

The cooling fan can be switched off when the fan or pump is not running to reduce both noise and energy consumption

● Synchronous Motor Control

Use of sensorless synchronous motor control together with the motor can reduce energy consumption



Network Capabilities

● RS-485 Communications Port as Standard

Communications can be controlled through the standard RS-485 communications port using the Modbus-RTU or Fuji Electric inverter protocol



RS-485 Communication Port



Other Features

● Functions for User Applications

- V/F (non-linear 3 step)
- Two motor parameter sets
- Brake signal (brake release signal)
- Rotational direction control (prevent forward/reverse movement)

● Global Standard

EC Directives (CE making)



UL standard (cUL certification)



Variation

Nominal Applied Motor (kW)[HP]	Three-phase 200V series	Three-phase 400V series	Single-phase 200V series	Single-phase 100V series
Standard specifications				
Without EMC filter type				
0.1 [1/8]	FRN0001C2S-2□		FRN0001C2S-7□	FRN0001C2S-6U
0.2 [1/4]	FRN0002C2S-2□		FRN0002C2S-7□	FRN0002C2S-6U
0.4 [1/2]	FRN0004C2S-2□	FRN0002C2S-4□	FRN0004C2S-7□	FRN0003C2S-6U
0.75 [1]	FRN0006C2S-2□	FRN0004C2S-4□	FRN0006C2S-7□	FRN0005C2S-6U
1.5 [2]	FRN0010C2S-2□	FRN0005C2S-4□	FRN0010C2S-7□	
2.2 [3]	FRN0012C2S-2□	FRN0007C2S-4□	FRN0012C2S-7□	
3.7 [5]	FRN0020C2S-2□	FRN0011C2S-4□		
5.5 [7.5]	FRN0025C2S-2□	FRN0013C2S-4□		
7.5 [10]	FRN0033C2S-2□	FRN0018C2S-4□		
11 [15]	FRN0047C2S-2□	FRN0024C2S-4□		
15 [20]	FRN0060C2S-2□	FRN0030C2S-4□		
Destination □	A(Asia), U(USA)	A(Asia), C(China), E(Europe), U(USA)		U(USA)
Semi-standard specifications				
EMC filter built-in type				
0.1 [1/8]			FRN0001C2E-7E	
0.2 [1/4]			FRN0002C2E-7E	
0.4 [1/2]		FRN0002C2E-4E	FRN0004C2E-7E	
0.75 [1]		FRN0004C2E-4E	FRN0006C2E-7E	
1.5 [2]		FRN0005C2E-4E	FRN0010C2E-7E	
2.2 [3]		FRN0007C2E-4E	FRN0012C2E-7E	
3.7 [5]		FRN0011C2E-4E		
5.5 [7.5]		FRN0013C2E-4E		
7.5 [10]		FRN0018C2E-4E		
11 [15]		FRN0024C2E-4E		
15 [20]		FRN0030C2E-4E		
Destination □			E(Europe)	

How To Read Model Number

FRN 0010 C 2 S - 4 A

Code	Series Name
FRN	FRENIC series
Applicable Current Rating	
This value shows an amperage rating 0001~0060	
Code	Application Range
C	Compact
Code	Developed Inverter Series
2	2-series
Code	Enclosure
S	Standard (IP20) (UL Open Type)
E	EMC filter built-in type

Code	Destination/Manual
A	Asia/English
C	China/Chinese
E	Europe/English
U	USA/English

Code	Input Power Source
2	Three-phase 200V
4	Three-phase 400V
6	Single-phase 100V
7	Single-phase 200V



Caution

The contents of this catalog are provided to help you select the product model that is best for you. Before actual use, be sure to read the User's Manual thoroughly to assure correct operation.

Features

Specifications

Terminal Functions

External Dimensions

Standard Model

Specifications

Three-phase 200V series

Item	Specifications											
Input power source	Three-phase 200V											
Type (FRN □□□□ C2S-2△, △=A, U)	FRN □□□□ C2S-2A, FRN □□□□ C2S-2U											
	0001	0002	0004	0006	0010	0012	0020	0025	0033	0047	0060	
Nominal applied motor[kW](△=A)	0.1	0.2	0.4	0.75	1.5	2.2	3.7	5.5	7.5	11	15	
Nominal applied motor[HP](△=U)	1/8	1/4	1/2	1	2	3	5	7.5	10	15	20	
Output ratings	Rated capacity[kVA]	0.30	0.57	1.3	2.0	3.5	4.5	7.2	9.5	12	17	22
	Rated voltage[V]	Three-phase 200 to 240V (With AVR)										
	Rated current[A>(*1)	0.8(0.7)	1.5(1.4)	3.5(2.5)	5.5(4.2)	9.2(7.0)	12.0(10.0)	19.1(16.5)	25.0(23.5)	33.0(31.0)	47.0(44.0)	60.0(57.0)
	Overload capability	150% of rated current for 1min 150% of rated current for 1min or 200% of rated current for 0.5s (If the rated current is in parenthesis)							150% of rated current for 1min or 200% of rated current for 0.5s			
Rated frequency[Hz]	50, 60Hz											
Input ratings	Phases, Voltage, Frequency	Three-phase, 200 to 240V, 50/60Hz										
	Voltage/Frequency variations	Voltage: +10 to -15% (Voltage unbalance : 2% or less), Frequency: +5 to -5%										
	Rated current[A] (with DCR)	0.57	0.93	1.6	3.0	5.7	8.3	14.0	21.1	28.8	42.2	57.6
	(without DCR)	1.1	1.8	3.1	5.3	9.5	13.2	22.2	31.5	42.7	60.7	80.0
Required power supply capacity[kVA]	0.2	0.3	0.6	1.1	2.0	2.9	4.9	7.4	10	15	20	
Braking	Torque[%]	150		100		50		30		20		
	DC injection braking	Starting frequency: 0.0 to 60.0Hz, Braking time: 0.0 to 30.0s Braking level: 0 to 100%										
	Braking transistor	-		Built-in								
Applicable safety standards	UL508C, EN 61800-5-1:2007											
Enclosure (IEC 60529)	IP20 (IEC 60529:1989) / UL open type (UL50)											
Cooling method	Natural cooling					Fan cooling						
Weight / Mass[kg(lbs)]	0.6(1.3)	0.6(1.3)	0.7(1.5)	0.8(1.8)	1.7(3.7)	1.7(3.7)	2.5(5.5)	3.1(6.8)	3.1(6.8)	4.5(9.8)	4.5(9.8)	

*1 The load shall be reduced so that the continuous operating current is the rated current in parenthesis or less if the carrier frequency is set to 3kHz or above or ambient temperature exceeds 40°C (104°F).

Three-phase 400V series

Item	Specifications										
Input power source	Three-phase 400V										
Type (FRN □□□□ C2S-4△, △=A, C, E, U)	FRN □□□□ C2S-4A, FRN □□□□ C2S-4C FRN □□□□ C2S-4E, FRN □□□□ C2S-4U										
	0002	0004	0005	0007	0011	0013	0018	0024	0030		
Nominal applied motor[kW] (△=A, C, E)	0.4	0.75	1.5	2.2	3.7(△=A, C) 4.0(△=E)	5.5	7.5	11	15		
Nominal applied motor[HP](△=U)	1/2	1	2	3	5	7.5	10	15	20		
Output ratings	Rated capacity[kVA]	1.3	2.3	3.2	4.8	8.0	9.9	13	18	22	
	Rated voltage[V]	Three-phase 380 to 480V (With AVR)									
	Rated current[A>(*1)	1.8(1.5)	3.1(2.5)	4.3(3.7)	6.3(5.5)	10.5(9.0)	13.0	18.0	24.0	30.0	
	Overload capability	150% of rated current for 1min 150% of rated current for 1min or 200% of rated current for 0.5s (If the rated current is in parenthesis)					150% of rated current for 1min or 200% of rated current for 0.5s				
Rated frequency[Hz]	50, 60Hz										
Input ratings	Phases, Voltage, Frequency	Three-phase, 380 to 480V, 50/60Hz									
	Voltage/Frequency variations	Voltage: +10 to -15% (Voltage unbalance : 2% or less), Frequency: +5 to -5%									
	Rated current[A] (with DCR)	0.85	1.6	3.0	4.4	7.3	10.6	14.4	21.1	28.8	
	(without DCR)	1.7	3.1	5.9	8.2	13.0	17.3	23.2	33.0	43.8	
Required power supply capacity[kVA]	0.6	1.1	2.0	2.9	4.9	7.4	10	15	20		
Braking	Torque[%]	100		50		30		20			
	DC injection braking	Starting frequency: 0.0 to 60.0Hz, Braking time: 0.0 to 30.0s Braking level: 0 to 100%									
	Braking transistor	Built-in									
Applicable safety standards	UL508C, EN 61800-5-1:2007										
Enclosure (IEC 60529)	IP20 (IEC 60529:1989) / UL open type (UL50)										
Cooling method	Natural cooling					Fan cooling					
Weight / Mass[kg(lbs)]	1.2(2.6)	1.3(2.9)	1.7(3.7)	1.7(3.7)	2.5(5.5)	3.1(6.8)	3.1(6.8)	4.5(9.8)	4.5(9.8)		

*1 The load shall be reduced so that the continuous operating current is the rated current in parenthesis or less if the carrier frequency is set to 3kHz or above or ambient temperature exceeds 40°C (104°F).

Specifications

Single-phase 200V/100V series

Item	Specifications									
Input power source	Single-phase 200V					Single-phase 100V				
Type (FRN □□□□C2S-□△, △=A, C, E, U)	FRN □□□□C2S-7A, FRN □□□□C2S-7C FRN □□□□C2S-7E, FRN □□□□C2S-7U					FRN □□□□C2S-6U				
Nominal applied motor[kW] (△=A, C, E)	0.1	0.2	0.4	0.75	1.5	2.2	0.1	0.2	0.4	0.75
Nominal applied motor[HP](△=U)	1/8	1/4	1/2	1	2	3	1/8	1/4	1/2	1
Rated capacity[kVA]	0.30	0.57	1.3	2.0	3.5	4.5	0.26	0.53	0.95	1.6
Rated voltage[V]	Three-phase 200 to 240V (With AVR)									
Rated current[A](*)	0.8(0.7)	1.5(1.4)	3.5(2.5)	5.5(4.2)	9.2(7.0)	12.0(10.0)	0.7	1.4	2.5	4.2
Overload capability	150% of rated current for 1min 150% of rated current for 1min or 200% of rated current for 0.5s (if the rated current is in parenthesis)					150% of rated current for 1min or 200% of rated current for 0.5s				
Rated frequency[Hz]	50, 60Hz									
Phases, Voltage, Frequency	Single-phase, 200 to 240V, 50/60Hz					Single-phase 100 to 120V, 50/60Hz				
Voltage/Frequency variations	Voltage: +10 to -10%, Frequency: +5 to -5%									
Rated current[A] (with DCR)	1.1	2.0	3.5	6.4	11.6	17.5	2.2	3.8	6.4	12.0
(without DCR)	1.8	3.3	5.4	9.7	16.4	24.0	3.6	5.9	9.5	16.0
Required power supply capacity[kVA]	0.3	0.4	0.7	1.3	2.4	3.5	0.3	0.5	0.7	1.3
Torque[%]	150		100		50	30	150		100	
DC injection braking	Starting frequency: 0.0 to 60.0Hz, Braking time: 0.0 to 30.0s, Braking level: 0 to 100%									
Braking transistor	-					Built-in				
Applicable safety standards	UL508C, EN 61800-5-1:2007					UL508C				
Enclosure (IEC 60529)	IP20 (IEC 60529:1989) / UL open type (UL50)									
Cooling method	Natural cooling					Fan cooling		Natural cooling		
Weight / Mass[kg(lbs)]	0.6(1.3)	0.6(1.3)	0.7(1.5)	0.9(2)	1.8(4)	2.5(5.5)	0.7(1.5)	0.7(1.5)	0.8(1.8)	1.3(2.9)

*1 The load shall be reduced so that the continuous operating current is the rated current in parenthesis or less if the carrier frequency is set to 3kHz or above or ambient temperature exceeds 40°C (104°F).

EMC Filter Built-in Model

Specifications

Three-phase 400V series

Item		Specifications								
Input power source		Three-phase 400V								
Type (FRN □□□□ C2E-4E)		FRN □□□□ C2E-4E								
		0002	0004	0005	0007	0011	0013	0018	0024	0030
Nominal applied motor[kW]		0.4	0.75	1.5	2.2	4.0	5.5	7.5	11	15
Nominal applied motor[HP]		1/2	1	2	3	5	7.5	10	15	20
Output ratings	Rated capacity[kVA]	1.3	2.3	3.2	4.8	8.0	9.9	13	18	22
	Rated voltage[V]	Three-phase 380 to 480V (With AVR)								
	Rated current[A>(*1)	1.8(1.5)	3.1(2.5)	4.3(3.7)	6.3(5.5)	10.5(9.0)	13	18	24	30
	Overload capability	150% of rated current for 1min 150% of rated current for 1min or 200% of rated current for 0.5s (If the rated current is in parenthesis)					150% of rated current for 1min or 200% of rated current for 0.5s			
Rated frequency[Hz]		50, 60Hz								
Input ratings	Phases, Voltage, Frequency	Three-phase, 380 to 480V, 50/60Hz								
	Voltage/Frequency variations	Voltage: +10 to -15% (Voltage unbalance : 2% or less), Frequency: +5 to -5%								
	Rated current[A] (with DCR)	0.85	1.6	3.0	4.4	7.3	10.6	14.4	21.1	28.8
	(without DCR)	1.7	3.1	5.9	8.2	13.0	17.3	23.2	33.0	43.8
Required power supply capacity[kVA]		0.6	1.1	2.0	2.9	4.9	7.4	10	15	20
Braking	Torque[%]	100		50	30	20				
	DC injection braking	Starting frequency: 0.0 to 60.0Hz, Braking time: 0.0 to 30.0s Braking level: 0 to 100%								
	Braking transistor	Built-in								
Applicable safety standards		UL508C, EN 61800-5-1:2007								
Applicable EMC standards (EN61800-3:2004 +A1:2012) (in progress)		Immunity : Second Environment (Industrial) Emission : Category C2					Immunity : Second Environment (Industrial) Emission : Category C3			
Enclosure (IEC 60529)		IP20 (IEC 60529:1989) / UL open type (UL50)								
Cooling method		Natural cooling			Fan cooling					
Weight / Mass[kg(lbs)]		1.5(3.3)	1.6(3.5)	3.0(6.6)	3.1(6.8)	3.2(7.1)	4.6(10.1)	4.6(10.1)	6.7(15)	6.7(15)

*1 The load shall be reduced so that the continuous operating current is the rated current in parenthesis or less if the carrier frequency is set to 3kHz or above or ambient temperature exceeds 40°C (104°F).







Single-phase 200V series

Item		Specifications					
Input power source		Single-phase 200V					
Type (FRN □□□□ C2E-7E)		FRN □□□□ C2E-7E					
		0001	0002	0004	0006	0010	0012
Nominal applied motor[kW]		0.1	0.2	0.4	0.75	1.5	2.2
Nominal applied motor[HP]		1/8	1/4	1/2	1	2	3
Output ratings	Rated capacity[kVA]	0.30	0.57	1.3	2.0	3.5	4.5
	Rated voltage[V]	Three-phase, 200 to 240V, 50/60Hz					
	Rated current[A>(*1)	0.8(0.7)	1.5(1.4)	3.5(2.5)	5.5(4.2)	9.2(7.0)	12.0(10.0)
	Overload capability	150% of rated current for 1min 150% of rated current for 1min or 200% of rated current for 0.5s (If the rated current is in parenthesis)					
Rated frequency[Hz]		50, 60Hz					
Input ratings	Phases, Voltage, Frequency	Single-phase, 200 to 240V, 50/60Hz					
	Voltage/Frequency variations	Voltage: +10 to -10%, Frequency: +5 to -5%					
	Rated current[A] (with DCR)	1.1	2.0	3.5	6.4	11.6	17.5
	(without DCR)	1.8	3.3	5.4	9.7	16.4	24.0
Required power supply capacity[kVA]		0.3	0.4	0.7	1.3	2.4	3.5
Braking	Torque[%]	150		100		50	
	DC injection braking	Starting frequency: 0.0 to 60.0Hz, Braking time: 0.0 to 30.0s, Braking level: 0 to 100%					
	Braking transistor	-		Built-in			
Applicable safety standards		UL508C, EN 61800-5-1:2007					
Applicable EMC standards (EN61800-3:2004 +A1:2012) (in progress)		Immunity : Second Environment (Industrial) Emission : Category C2					
Enclosure (IEC 60529)		IP20 (IEC 60529:1989) / UL open type (UL50)					
Cooling method		Natural cooling				Fan cooling	
Weight / Mass[kg(lbs)]		0.7(1.5)	0.7(1.5)	0.8(1.8)	1.2(2.6)	3.0(6.6)	3.0(6.6)

*1 The load shall be reduced so that the continuous operating current is the rated current in parenthesis or less if the carrier frequency is set to 3kHz or above or ambient temperature exceeds 40°C (104°F).

Common Specifications

Common Specifications

Item		Explanation	Remarks
Output frequency	Setting range		
	Maximum frequency	25 to 400Hz	
	Base frequency	25 to 400Hz	
	Starting frequency	0.1 to 60.0Hz	
Carrier frequency		0.75 to 16kHz	
		Note: The unit is equipped with an automatic reduction/stop function that may automatically drop the carrier frequency to protect the inverter when it is running at frequencies above 6 kHz, depending on ambient temperature, output current, and other conditions. (*1)	
		- Under modulated carrier conditions, the system scatters carrier frequency to reduce noise	
Accuracy (stability)		- Analog setting: : Absolute accuracy within $\pm 2\%$ (at 25°C(77°F)), temperature drift within $\pm 0.2\%$ (25°C(77°F) \pm 10°C(50°F)) - Keypad setting: : Absolute accuracy within $\pm 0.01\%$ (at 25°C(77°F)), temperature drift within $\pm 0.01\%$ (25°C(77°F) \pm 10°C(50°F))	
Setting resolution		- Analog setting : 1/1000 of maximum frequency - Keypad setting : 0.01Hz (99.99Hz or less), 0.1Hz (100.0Hz to 400.0Hz) - Link operation : 1/20000 of maximum frequency or 0.01Hz (fixed)	
Control method		Induction motor drive - V/f control - Slip compensation - Automatic torque boost - Dynamic torque vector control - Automatic energy-saving function	
		Synchronous motor drive - Sensorless magnetic positioning (speed control range: 10% of base frequency and up)	
Voltage/freq. characteristic	200V series	Base frequency and maximum output frequency can each be set between :80 to 240 AVR control (*1) can be turned ON or OFF Allowable non-linear V/f (*1) settings (2): optional voltage (0–240V) and frequency (0–400Hz)	
	400V series	Base frequency and maximum output frequency can each be set between :160 to 500 AVR control (*1) can be turned ON or OFF Allowable non-linear V/f (*1) settings (2): optional voltage (0–500V) and frequency (0–400Hz)	
Torque boost (*1)		- Automatic torque boost (for constant torque loads)	
		- Manual torque boost: Optional torque boost value can be set between 0.0 and 20.0%	
		- Application load can be selected (for constant and variable torque loads)	
Starting torque (*1)		150% or more/frequency set to 3Hz Slip compensation /automatic torque boost active	
Control	Start/stop	Keypad operation : Start and stop with  ,  keys (standard keypad) : Start and stop with  ,  keys (remote keypad: optional)	
		External signals (digital input) : FWD (REV) operation/stop command [3-wire operation enabled] Coast-to-stop command, trip command (external fault), fault reset, etc.	
	Link operation : Communication via RS-485		
	Changing run command: Communications used to change run command		
Frequency setting	Keypad operation : Can be set with  or  key (with save data function) Also can be set with function code (only via communication) and be copied.(*2)		
	Set based on built-in volume		
	Analog input : 0 to +10V DC/0 to 100% (terminal 12) : 4 to +20mA DC/0 to 100%, 0 to +20mA DC/0 to 100% (terminal C1)		
	Multistep frequency : Selectable from 16 steps (step 0 to 15)		
	UP/DOWN operation : Raises or lowers frequency while digital input signal is ON		
	Link operation: : Frequency set through RS-485 communication		
	Changing frequency settings : Two types of frequency settings can be changed using external signals (digital input) : frequency settings and multistep frequency settings		
	Auxiliary frequency setting : Built-in potentiometer, Inputs at terminal 12, C1 can be added to the main setting as auxiliary frequency settings.		
Inverse operation : Can be switched from (DC 0 to +10V/0 to 100%) to (DC +10 to 0V/0 to 100%) externally : Can be switched from (DC 4 to 20mA (DC 0–20mA)/0 to 100%) to (DC 20 to 4mA (DC 20–0mA)/0 to 100%) externally			
Acceleration/deceleration time		- Can be set between 0.00 and 3600s - There are two independent settings that can be selected for acceleration/deceleration time (can be switched while running) - Pattern : The following four acceleration/deceleration types can be selected Linear, S-curve (weak/strong), non-linear (constant output maximum capacity acceleration/deceleration) - Coast-to-stop acceleration/deceleration is enabled when run commands are OFF - Acceleration/deceleration time can be set during jogging operation (between 0.00 and 3600s)	

*1 Only valid when induction motor drive is in operation

Common Specifications

Common Specifications

Item	Explanation	Remarks
Frequency limiter (Peak/bottom frequency limit)	High and low limiters can be set in addition to Hz values (0–400Hz)	
Bias frequency	Bias of set frequency and PID command can be set separately between 0 and ±100%	
Gain for frequency setting	Analog input gain can be set between 0 and 200%	
Jump frequency control	Three operation points and their common jump hysteresis width can be set (0–30Hz) Six operation points and their common jump hysteresis width can be set (0–30Hz) (*2)	
Timer operation	Operation starts and stops at the time set from keypad (1 cycle)	
Jogging operation (*1)	Operated using the PLN key (on the standard or remote keypad) or digital contact point input (acceleration and deceleration time--same duration used only for jogging)	
Auto-restart after momentary power failure (*1)	<ul style="list-style-type: none"> • Trip at power failure: The inverter trips immediately after power failure. • Trip at power recovery: Coast-to-stop at power failure and trip at power recovery • Deceleration stop: Deceleration stop at power failure, and trip after stoppage (*2) • Start at the frequency selected before momentary stop: Coast-to-stop at power failure and start after power recovery at the frequency selected before momentary stop. • Start at starting frequency: Coast-to-stop at power failure and start at the starting frequency after power recovery. 	
Current limit by hardware (*1)	Uses hardware to limit current and prevent overcurrent trips resulting from sudden load changes, momentary power failures, and similar events that cannot be handled by software current limiters (can be canceled)	
Slip compensation (*1)	Compensates for decrease in speed according to the load, enabling stable operation	
Current limit	Keeps the current under the preset value during operation	
PID control	Process PID regulator • PID command, keyboard, analog input (terminal 12, C1), RS-485 communication • Feedback value: Analog input (terminal 12, C1) • Low liquid level stop function • Switch forward/reverse operation • Integration reset/hold function	
Automatic deceleration	<ul style="list-style-type: none"> • Automatically limits output frequency, limits energy generated by the inverter, and avoids overcurrent trips when torque relay value is exceeded (*1) • Makes deceleration time three times longer to avoid OU trip when DC link circuit voltage exceeds overage limit 	
Deceleration characteristics (improved braking capacity)	Increases motor loss and reduces energy generated by the inverter during deceleration to avoid overcurrent trips	
Energy saving operation (*1)	Restricts output voltage to minimize total motor and inverter loss during constant speed operation	
Overload prevention control	Lowers frequency when IGBT junction temperature and ambient temperature rise due to overloading to avoid further overload	
Offline tuning (*1)	Performs r1, Xσ, and excitation current tuning Performs r1, Xσ, slip frequency and excitation current tuning (*2)	
Fan stop operation	Detects inverter internal temperature and stops cooling fan when the temperature is low	
Secondary motor settings	<ul style="list-style-type: none"> • Switching between two motors in the same inverter is enabled (switching cannot be performed while the inverter is running) Induction motor settings can only be applied to the second motor Data settings (base frequency, rated current, torque boost, electronic thermal, and slip compensation, etc.) can be entered for the second motor • Constants can be set within the second motor. Auto-tuning is also enabled. 	
Rotational direction limits	Select either prevent reverse or prevent forward operation	
Running/stopping	Speed monitor, output current [A], output voltage [V], input power [kW], PID reference, PID feedback value, PID output, timer value (for timer operation) [s], total power amount Select the speed monitor to be displayed from the following: Output frequency (before slip compensation) [Hz], output frequency (after slip compensation) [Hz], set frequency [Hz], load shaft speed [min ⁻¹], line speed [m/min], constant rate of feeding time [min]	
Lifetime alarm	Displays the lifetime alarm for the main circuit condenser, PCB condenser, and cooling fan. External output is enabled for lifetime alarm information.	
Total running time	Can display total motor running time, total inverter running time, and total power use	
I/O check	Displays control circuit terminal output status	
Energy saving monitor	Power consumption, power consumption x coefficient	
Trip mode	Displays cause of trip: • OC1 : Overcurrent during acceleration • OC2 : Overcurrent during deceleration • OC3 : Overcurrent at constant speed • Lrn : Input phase loss • LU : Undervoltage • OPL : Output phase loss • OU1 : Overvoltage during acceleration • OU2 : Overvoltage during deceleration • OU3 : Overvoltage during constant speed • DH1 : Overheating of the heat sink • DH2 : External thermal relay tripped • DH4 : Motor protection (PTC thermistor) • dbH : Overheating of the DB circuit • CoF : PID feedback break detected • OL1 : Overload in motor 1 • OL2 : Overload in motor 2 • OLU : Inverter unit overload • Er1 : Memory error • Er2 : Keypad communication error • Er3 : CPU error • Er5 : Operation procedure error • Er7 : Tuning error • Er8 : RS485 error • ErF : Data save error due to undervoltage • Er d : Step out detected (for synchronous motor drive) (*2) • Err : Mock error	
Running or Trip mode	Trip history: Saves and displays the last 4 trip codes and their detailed description Saves and displays detailed data for each section on up to four past trips	

*1 Only valid when induction motor drive is in operation

*2 These functions can be supported by the inverters having a ROM version 0500 or later

Common Specifications

Item	Explanation		Remarks
Overcurrent	Stops the inverter to protect against overcurrent due to overload		LED display OC1 OC2 OC3
Short-circuit	Stops the inverter to protect against overcurrent due to a short circuit in the output circuit		
Ground fault	Stops the inverter to protect against overcurrent due to a ground fault (initial ground circuit only) in the output circuit		
Overvoltage	Detects excess voltage in DC link circuit (200V: DC 400V,400V: DC 800V) and stops the inverter Cannot protect against significantly large voltage input mistakenly applied		OU1 OU2 OU3
Undervoltage	Detects drops in DC link circuit voltage (200V: DC 200V,400V: DC400V) and stops the inverter Note that no alarm will sound if auto-restart after momentary power failure is selected		LU
Input phase loss	Stops or protects the inverter against input phase loss Even when there is input phase loss, the loss may not be detected if the connected load is light or a DC reactor is connected to the inverter		Lin
Output phase loss detected	Detects loss from breaks in output wiring while running or during startup and stops the inverter		OPL
Overheating	Stops the inverter by detecting the temperature of the inverter cooling system (e.g. when the cooling fan is malfunctioning or there is an overload)		OH1
	Protects against overheating during braking resistance based on braking resistor electronic thermal function settings		dbH
Overload	Stops the inverter based on the temperature of the cooling system and the switching element calculated from output current flow		OLU
External alarm input	Stops the inverter alarm through digital input (THR)		OH2
Motor protection	Electronic thermal	Stops running the inverter to protect the motor according to electronic thermal function settings	OL1 OL2
		Protects the standard motor and inverter motor over the full frequency range. The second motor can also be protected. (Operation level and thermal time constant can be set between 0.5 and 75.0 minutes)	
	PTC thermistor	· Stops running the inverter to protect the motor when the PTC thermistor detects motor temperature A PTC thermistor is connected between terminals C1 and 11, and a resistor is connected between terminals 13 and C1. Set function code.	OH4
	Overload early warning	Outputs a preliminary alarm at a preset level before the electronic thermal stops the inverter	—
Memory error	Checks data when the power is turned on and data is being written, and stops the inverter if a memory malfunction is detected.		Er1
Keypad communication error	Stops the inverter if a communication malfunction is detected between the keypad and inverter unit while an operation command is in progress from the remote keypad		Er2
CPU error	Stops the inverter if a CPU malfunction caused by noise or similar factors is detected		Er3
Operation error	STOP key priority	Pressing the STOP key on the keypad forces the inverter to stop, even if run commands are being delivered via terminals or communications. Er6 is displayed once stop is complete.	Er6
	Start check	Prohibits run operations and displays Er6 if a run command is given while any of the following status changes are occurring: · Powering up · Canceling an alarm · Switching run command methods via link operation	
Tuning error (*1)	Stops the inverter when there is a tuning failure, interruption, or abnormality in tuning results during motor constant tuning		Er7
RS-485 communication error	Stops the inverter if a communications malfunction is detected in RS-485 communication with the inverter unit		Er8
Data save error during undervoltage	Displays an error if data save cannot proceed normally because an undervoltage protection function is activated		ErF
Step out detected (*2)	Stops the inverter when a synchronous motor step out is detected		Erd
PID feedback break detected	Stops the inverter when a break is detected during current input (C1 terminal) distribution to PID feedback (can be enabled/disabled)		CoF
Stall prevention	Output frequency is reduced to avoid an overcurrent trip when output current exceeds the limit during acceleration/deceleration or constant speed operation		
Alarm output (for any fault)	· Outputs a relay signal when the inverter is stopped due to an alarm · Alarm stop status can be canceled by pressing the PRG/RESET key or by inputting a digital signal (RST)		
Retry	Inverter can be automatically reset and restarted after stopping due to a trip (the number of retries and wait time until reset can also be set)		
Incoming surge	Protects the inverter from surge voltage between the main circuit and ground terminal		
Momentary power failure	· Launches a protective function (stops the inverter) when there is a momentary power failure of 15ms or more · Restarts and restores voltage within the set time when momentary power failure restart is selected		
Mock malfunction	Can output a mock alarm to check malfunction sequences		Err
Environment	Installation location	· Must be indoors and free of corrosive gases, flammable gases, dust, and oil mist (contamination level 2 (IEC 60664-1: 2007) · Keep out of direct sunlight	
	Ambient temperature	Open: -10°C (14°F) to + 50°C (122°F) (IP20)	
	Ambient humidity	5 to 95%RH (no condensation)	
	Altitude	1000m (3300ft) or less (Output derating is not necessary.) Above 1000m (3300ft) to 3000m (9800ft) or less (Output derating is necessary.) Above 1000m (3300ft) to 1500m (4900ft) or lower : 0.97, Above 1500m (4900ft) to 2000m (6600ft) or lower : 0.95, Above 1000m (3300ft) to 2500m (8200ft) or lower : 0.91, Above 2500m (8200ft) to 3000m (9800ft) lower : 0.88	
	Vibration	3mm (0.12inch) (vibration width): 2 to less than 9Hz, 9.8m/s ² : 9 to less than 20Hz, 2m/s ² : 20 to less than 55Hz, 1m/s ² : 55 to less than 200Hz	
	Saved temperature	-25°C (77°F) ± 70°C (158°F)	
Saved humidity	5 to 95%RH (no condensation)		

*1 Only valid when induction motor drive is in operation

*2 These functions can be supported by the inverters having a ROM version 0500 or later

Terminal Functions

Terminal Functions

Category	Symbol	Terminal Name	Functions	Remarks																																																																																																																														
Main circuit	L1/R,L2/S,L3/T	Power input	Connect a three-phase power supply (three-phase 200V,400V)																																																																																																																															
	U,V,W	Inverter output	Connect a three-phase induction motor																																																																																																																															
	P(+),P1	For DC REACTOR	Connect the DC REACTOR																																																																																																																															
	P(+),N(-)	For DC bus connection	Used for DC bus connection system																																																																																																																															
	P(+),DB	For EXTERNAL BRAKING RESISTOR	Connect external braking resistor	Only for 0.4kW and above. Connections are enabled for 0.2kW and below, but operation will not work.																																																																																																																														
	●G(2-terminal)	Grounding	Ground terminal for inverter chassis																																																																																																																															
Frequency setting	13	Potentiometer power supply	Power supply for frequency setting potentiometer (1 to 5kΩ)	DC10V																																																																																																																														
	12	Voltage input	· Used as voltage input for frequency setting 0 to +10V DC/0 to 100%																																																																																																																															
		(Inverse operation) (PID control) (Frequency aux. setting)	· +10 to +0V DC/0 to 100% · Used for reference signal (PID process command) or feedback signal · Used as additional auxiliary setting to various main settings of frequency																																																																																																																															
	C1	Current input	· Used as current input for frequency setting +4 to +20mA DC (0 to +20mA DC)/0 to 100%																																																																																																																															
		(Inverse operation) (PID control) (Frequency aux. setting)	· +4 to +20mA DC (0 to +20mA DC)/0 to 100% · Used for reference signal (PID process command) or feedback signal · Used as additional auxiliary setting to various main settings of frequency																																																																																																																															
(For PTC thermistor)		· Connects PTC thermistor for motor protection																																																																																																																																
11(2-terminal)	Common	Common terminal for frequency setting signal (12, 13, C1, FMA)	Isolated from terminal CM and Y1E																																																																																																																															
Digital input	X1	Digital input 1	The following functions can be set at terminals X1 to X3, FWD, and REV for signal input. - Common function · Switch between synch/source using the built-in switches on the unit · Short-circuit ON or open circuit ON settings are enabled between the terminal X1 and CM The same setting is possible between CM and any of the terminals among X2, X3, FWD, and REV.																																																																																																																															
	X2	Digital input 2																																																																																																																																
	X3	Digital input 3																																																																																																																																
	FWD	Forward operation command																																																																																																																																
	REV	Reverse operation command																																																																																																																																
	(FWD)	Forward operation command	The motor runs in the forward direction when (FWD) is ON, stops after deceleration when FWD is OFF	Only terminal FWD/REV settings are allowed, only short circuit ON																																																																																																																														
	(REV)	Reverse operation command	The motor runs in the reverse direction when (REV) is ON, stops after deceleration when REV is OFF	do.																																																																																																																														
	(SS1) (SS2) (SS4) (SS8)	Multistep freq. selection	16-speed operation is enabled using the ON/OFF signal from (SS1) through (SS8)																																																																																																																															
				<table border="1"> <thead> <tr> <th colspan="2"></th> <th colspan="16">Frequency</th> </tr> <tr> <th colspan="2">Digital input</th> <th>0</th><th>1</th><th>2</th><th>3</th><th>4</th><th>5</th><th>6</th><th>7</th><th>8</th><th>9</th><th>10</th><th>11</th><th>12</th><th>13</th><th>14</th><th>15</th> </tr> </thead> <tbody> <tr> <td>(SS1)</td> <td>-</td> <td>ON</td><td>-</td><td>ON</td><td>-</td><td>ON</td><td>-</td><td>ON</td><td>-</td><td>ON</td><td>-</td><td>ON</td><td>-</td><td>ON</td><td>-</td><td>ON</td><td>-</td><td>ON</td> </tr> <tr> <td>(SS2)</td> <td>-</td> <td>-</td><td>ON</td><td>ON</td><td>-</td><td>-</td><td>ON</td><td>ON</td><td>-</td><td>-</td><td>ON</td><td>ON</td><td>-</td><td>-</td><td>ON</td><td>ON</td><td>-</td><td>-</td><td>ON</td><td>ON</td> </tr> <tr> <td>(SS4)</td> <td>-</td> <td>-</td><td>-</td><td>-</td><td>ON</td><td>ON</td><td>ON</td><td>ON</td><td>-</td><td>-</td><td>-</td><td>-</td><td>ON</td><td>ON</td><td>ON</td><td>ON</td><td>-</td><td>-</td><td>-</td><td>-</td><td>ON</td><td>ON</td><td>ON</td><td>ON</td> </tr> <tr> <td>(SS8)</td> <td>-</td> <td>-</td><td>-</td><td>-</td><td>-</td><td>-</td><td>-</td><td>-</td><td>-</td><td>-</td><td>-</td><td>ON</td><td>ON</td><td>ON</td><td>ON</td><td>ON</td><td>ON</td><td>ON</td><td>ON</td><td>ON</td><td>ON</td><td>ON</td><td>ON</td><td>ON</td> </tr> </tbody> </table>			Frequency																Digital input		0	1	2	3	4	5	6	7	8	9	10	11	12	13	14	15	(SS1)	-	ON	-	ON	-	ON	-	ON	-	ON	-	ON	-	ON	-	ON	-	ON	(SS2)	-	-	ON	ON	-	-	ON	ON	-	-	ON	ON	-	-	ON	ON	-	-	ON	ON	(SS4)	-	-	-	-	ON	ON	ON	ON	-	-	-	-	ON	ON	ON	ON	-	-	-	-	ON	ON	ON	ON	(SS8)	-	-	-	-	-	-	-	-	-	-	-	ON	ON	ON	ON	ON	ON	ON	ON	ON	ON	ON	ON	ON
			Frequency																																																																																																																															
	Digital input		0	1	2	3	4	5	6	7	8	9	10	11	12	13	14	15																																																																																																																
	(SS1)	-	ON	-	ON	-	ON	-	ON	-	ON	-	ON	-	ON	-	ON	-	ON																																																																																																															
	(SS2)	-	-	ON	ON	-	-	ON	ON	-	-	ON	ON	-	-	ON	ON	-	-	ON	ON																																																																																																													
	(SS4)	-	-	-	-	ON	ON	ON	ON	-	-	-	-	ON	ON	ON	ON	-	-	-	-	ON	ON	ON	ON																																																																																																									
	(SS8)	-	-	-	-	-	-	-	-	-	-	-	ON	ON	ON	ON	ON	ON	ON	ON	ON	ON	ON	ON	ON																																																																																																									
(RT1)	ACC/DEC selection	Acceleration/deceleration time setting 1 is active when RT1 is OFF Acceleration/deceleration time setting 2 is active when RT1 is ON																																																																																																																																
(HLD)	3-wire operation stop command	· Used as an automatic hold signal during 3-wire operation · The FWD or REV signal is automatically stopped when HLD is ON, and the hold is removed when HLD is OFF																																																																																																																																
(BX)	Coast-to-stop command	When BX is ON, inverter output is shut off immediately and the motor coasts-to-stop (no alarm output)																																																																																																																																
(RST)	Alarm reset	Alarm hold status is removed when RST is ON	Signal at 0.1s or higher																																																																																																																															
(THR)	Trip command (External fault)	When THR is OFF, inverter output is shut off immediately and the motor coasts-to-stop (alarm output enabled: OH2)																																																																																																																																
(JOG)	Jogging operation	Turn JOG ON to enable jogging operation: switches the running mode to jogging mode, the frequency setting to jogging frequency, and acceleration/deceleration time to jogging running use	(*1)																																																																																																																															
(Hz2/Hz1)	Freq. set 2/ Freq. set 1	Frequency setting 2 is selected when Hz2/Hz1 is ON																																																																																																																																
(M2/M1)	Motor 2/Motor 1	Motor 1 settings take effect when M2/M1 is OFF. Motor 2 settings take effect when M2/M1 is ON.																																																																																																																																

*1 Only valid when induction motor drive is in operation

Terminal Functions

Category	Symbol	Terminal Name	Functions	Remarks
Digital input	(DCBRK)	DC brake command	Turn DCBRK ON to start direct current braking	
	(WE-KP)	Write enable for KEYPAD	Function code data changes can only be made when the keypad is turned ON with WE-KP	
	(UP)	UP command	Output frequency increases while UP is ON	
	(DOWN)	DOWN command	Output frequency decreases while DOWN is ON	
	(Hz/PID)	PID control cancel	PID control is canceled when Hz/PID is ON (runs based on multistep frequency/keypad/analog input etc.)	
	(IVS)	Inverse mode changeover	Switch from analog frequency setting or PID control output signal (frequency setting) operation mode to forward/reverse operation. Reverse operation enabled when IVS is ON.	
	(LE)	Link enable (RS485, Bus)	Operates according to commands from RS-485 when LE is ON	
	(PID-RST)	PID integral/differential reset	Turn PID-RST ON to reset PID integration and differential values	
	(PID-HLD)	PID integral hold	Turn PID-HLD ON to hold PID differentiation	
	PLC	PLC terminal	Connect to PLC output signal power supply Common for 24V power	+24V (22–27V) Max 50mA
CM(2-terminal)	Common	Common for digital input signal	Isolated from terminal 11 and Y1E	
Transistor output	(PLC)	Transistor output power	Power supply for transistor output load (Max: DC 24V DC 50mA) (Caution: Same terminal as digital input PLC terminal)	Short circuit between terminal CM and Y1E is used
	Y1	Transistor output	Select one of the following signals for output: Short circuit when ON signal is output or open circuit when ON signal is output	Max. voltage: 27Vdc, max. current: 50mA, leak current: 0.1mA ^{***} , ON voltage: within 2V(at 50mA)
	(RUN)	Inverter running (speed exists)	Comes ON when the output frequency is higher than starting frequency	
	(FAR)	Speed/freq. arrival	Comes ON when the difference between output frequency and set frequency rises above the frequency arrival detection range (function code E30)	
	(FDT)	Speed/freq. detection	Comes ON when output frequency falls below operational level (function code E31). Turns OFF when it falls below operational level (function code E31) or hysteresis width (function code E32).	
	(LU)	Undervoltage detection	Comes ON when there is a run command and running has stopped due to insufficient voltage	
	(IOL)	Inverter output limit	Comes ON when the inverter is experiencing limited current, automatic deceleration, or limited torque operation	
	(IPF)	Auto-restarting	Comes ON during auto restart operation (after momentary power failure and until completion of restart).	
	(OL)	Overload early warning	Comes ON when the electronic thermal relay value is higher than the preset alarm level	
	(SWM2)	Switch to Motor 2	Comes ON when Motor 2 is selected by inputting a motor switch signal (M2/M1)	
	(TRY)	Auto-resetting mode	Comes ON during auto reset mode	
	(LIFE)	Lifetime alarm	Alarm signal is output according to lifetime assessment standards inside the inverter	
	(PID-CTL)	PID control in progress	Comes ON when PID control is in effect	
	(PID-STP)	PID low water volume stop in progress	Comes ON when low liquid level stop is in effect in PID control (also stops based on the status of input run command)	
	(RUN2)	Inverter output in progress	Comes ON when the inverter is running above startup frequency and DC braking is also in operation (Comes ON when the inverter main circuit (gate) is ON)	
	(OLP)	Overload preventive control	Comes ON when overload prevention control is operating	
	(ID2)	Current detection 2	Comes ON when a current larger than the set value (for ID2) is continuously detected for longer than the time set on the timer	
	(THM)	Thermistor detected	Comes ON when motor overheating is detected by the PTC/NTC thermistor	(*1)
	(BRKS)	Brake signal	Outputs a brake engage/release signal	(*1)
	(MNT)	Maintenance timer	Alarm signal is generated when time passes or start-up exceeds over the preset value	(*2)
(FARFDT)	Frequency arrival/frequency detected	Comes ON when both (FAR) and (FDT) are ON		
(C1OFF)	C1 terminal break detected	Comes ON when the system determines that a break will occur if terminal C1 input falls below 2mA		
(ID)	Current detection	Comes ON when a current larger than the set value has been detected for the timer-set time		

*1 Only valid when induction motor drive is in operation

*2 These functions can be supported by the inverters having a ROM version 0500 or later

Terminal Functions

Terminal Functions				
Category	Symbol	Terminal Name	Functions	Remarks
Transistor output	(IDL)	Small current detection	Comes ON when a current smaller than the set value has been detected for the timer-set time	
	(ALM)	Alarm relay (for any fault)	Alarm signal is output as the transistor output signal	
	Y1E	Transistor output common	Common terminal for transistor output	Isolated from terminal 11 and CM
Relay output	30A, 30B, 30C	Alarm relay output (for any fault)	Outputs a no-voltage contact signal (1c) when the inverter stops the alarm Can select the same signal as the Y1 signal for multipurpose relay output · Can switch between alarm output through excitation operation and alarm output through non-excitation operation	Contact rating : AC250V, 0.3A, cosφ=0.3 DC48V, 0.5A
Analog output	FMA	Analog monitor	Output format: DC voltage (0–10V) Output can be performed in one of the following selected analog formats · Output frequency 1 (Before slip compensation) · Output frequency 2 (After slip compensation) · Output current · Output voltage · Input power · PID feedback value · DC link circuit voltage · Analog output test · PID command · PID output	Gain setting between 0 and 300%
LINK		Built-in RJ-45 connector (RS-485 communication)	Any of the following protocols can be selected: · Dedicated keypad protocol (automatically selected) · Modbus RTU · Fuji dedicated inverter protocol · SX protocol (for PC loader)	Provides power to the keypad Includes terminator ON/OFF switch Communication data storage can be selected. (*2)

*2 These functions can be supported by the inverters having a ROM version 0500 or later

Terminal Functions

Terminal Arrangement

Main circuit terminals

Power source	Nominal Applied Motor (kW(HP))	Inverter Type	Reference
Three-phase 200V	0.1 (1/8)	FRN0001C2S-2□	Fig. A
	0.2 (1/4)	FRN0002C2S-2□	
	0.4 (1/2)	FRN0004C2S-2□	
	0.75 (1)	FRN0006C2S-2□	
	1.5 (2)	FRN0010C2S-2□	Fig. B
	2.2 (3)	FRN0012C2S-2□	
	3.7 (5)	FRN0020C2S-2□	Fig. E
	5.5(7.5)	FRN0025C2S-2□	
7.5(10)	FRN0033C2S-2□	Fig. F	
11(15)	FRN0047C2S-2□		
15(20)	FRN0060C2S-2□		
Three-phase 400V	0.4 (1/2)	FRN0002C2□-4□	Fig. B
	0.75 (1)	FRN0004C2□-4□	
	1.5 (2)	FRN0005C2□-4□	
	2.2 (3)	FRN0007C2□-4□	
	3.7 (5)	FRN0011C2□-4□	Fig. E
	5.5(7.5)	FRN0013C2S-4□	
	7.5(10)	FRN0018C2S-4□	Fig. F
	11(15)	FRN0024C2S-4□	
15(20)	FRN0030C2S-4□	Fig. G	
5.5(7.5)	FRN0013C2E-4E		
7.5(10)	FRN0018C2E-4E	Fig. H	
11(15)	FRN0024C2E-4E		
15(20)	FRN0030C2E-4E		
Single-phase 200V	0.1 (1/8)	FRN0001C2□-7□	Fig. C
	0.2 (1/4)	FRN0002C2□-7□	
	0.4 (1/2)	FRN0004C2□-7□	Fig. D
	0.75 (1)	FRN0006C2□-7□	
	1.5 (2)	FRN0010C2□-7□	
2.2 (3)	FRN0012C2□-7□		
Single-phase 100V	0.1 (1/8)	FRN0001C2S-6U	Fig. C
	0.2 (1/4)	FRN0002C2S-6U	
	0.4 (1/2)	FRN0003C2S-6U	

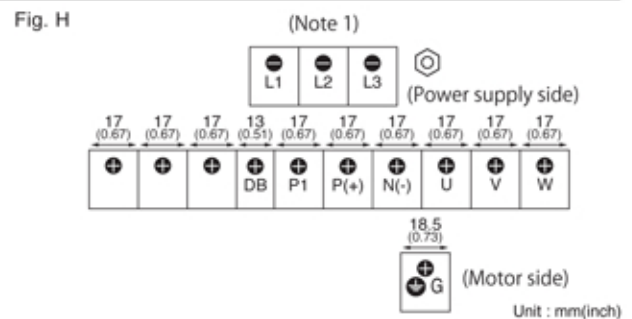
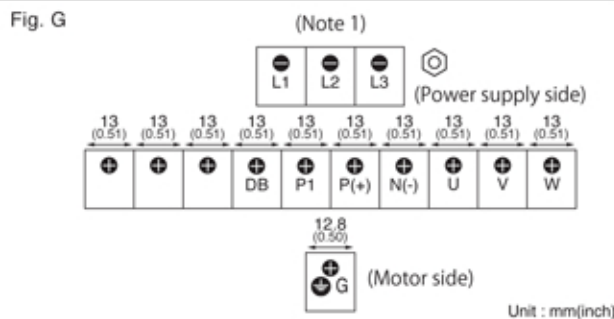
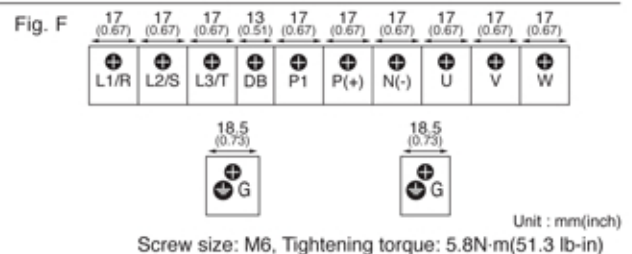
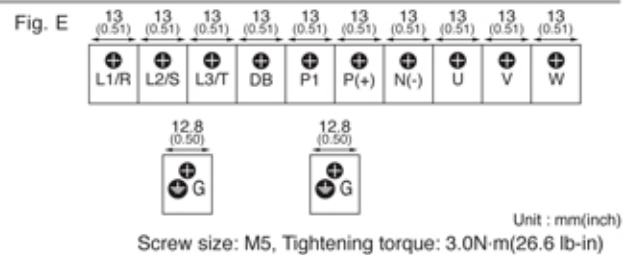
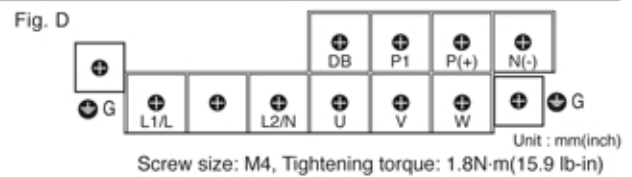
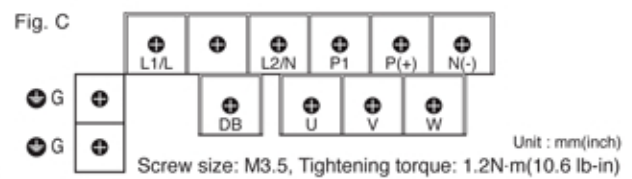
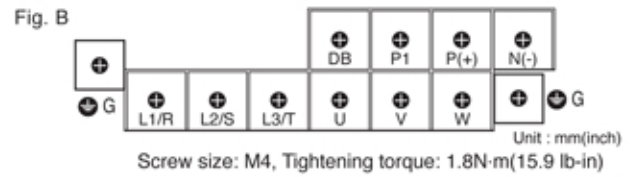
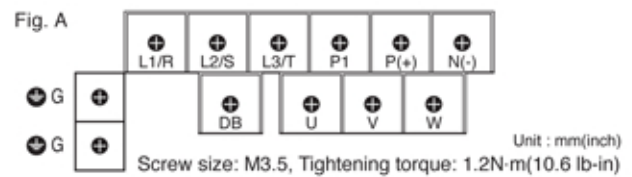

Control Circuit Terminals

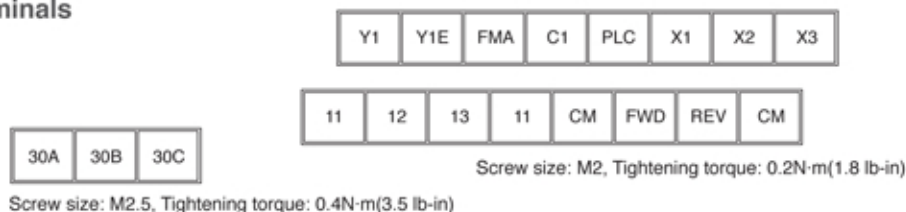

External Dimensions

Standard Model

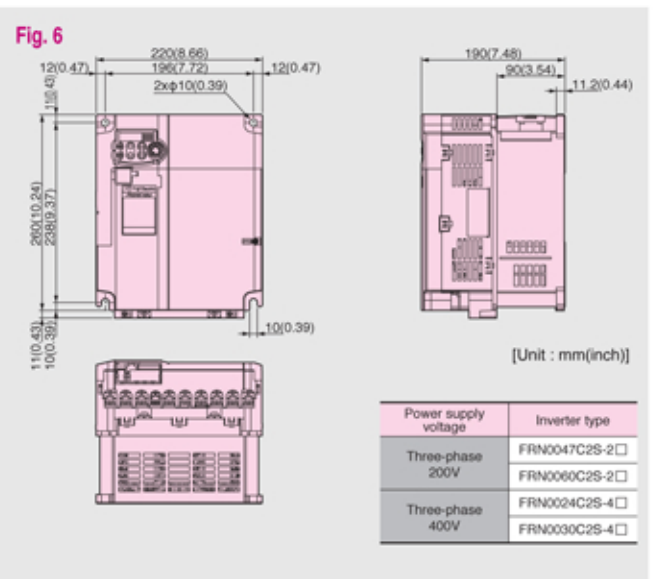
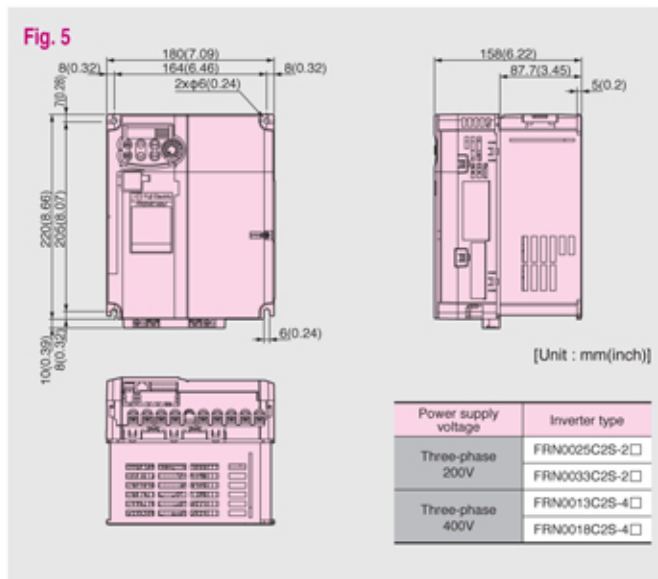
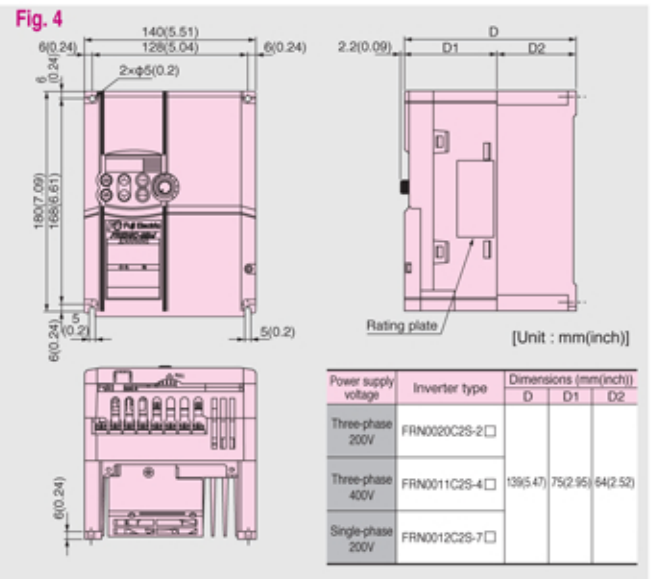
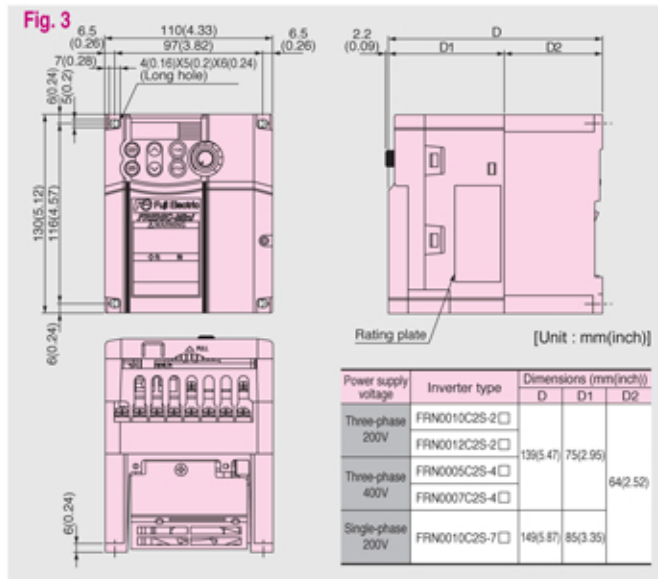
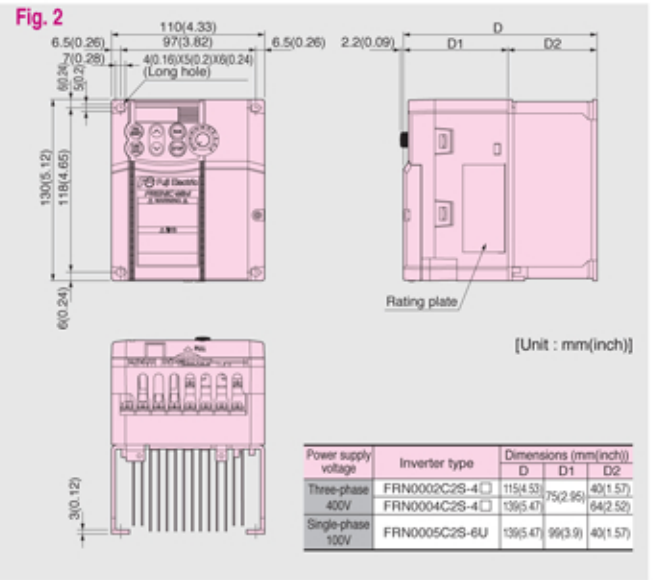
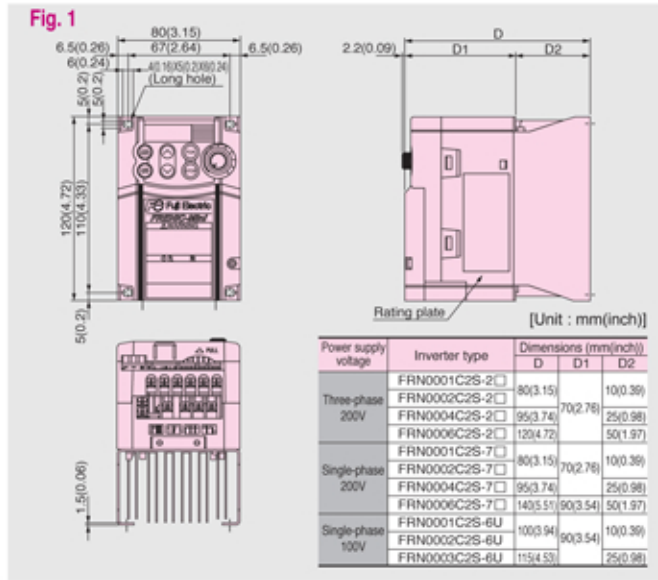

EMC Filter Built-in Model

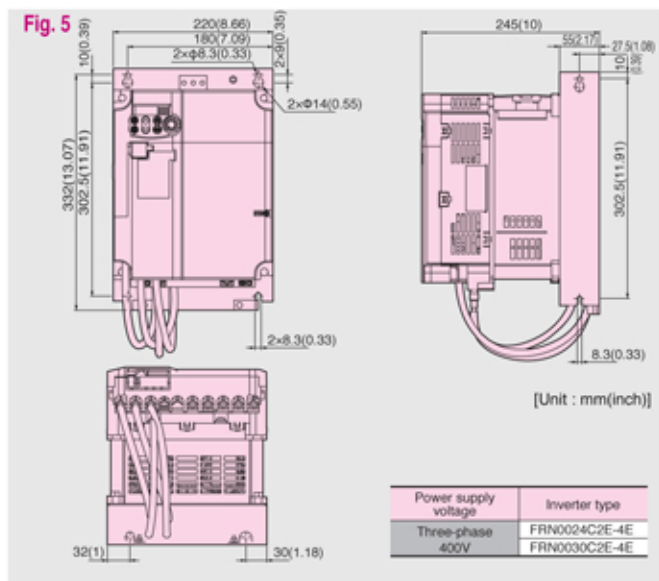
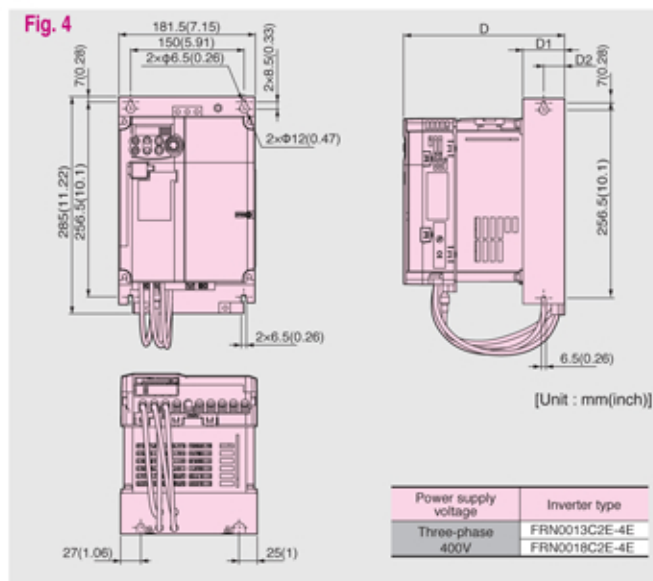
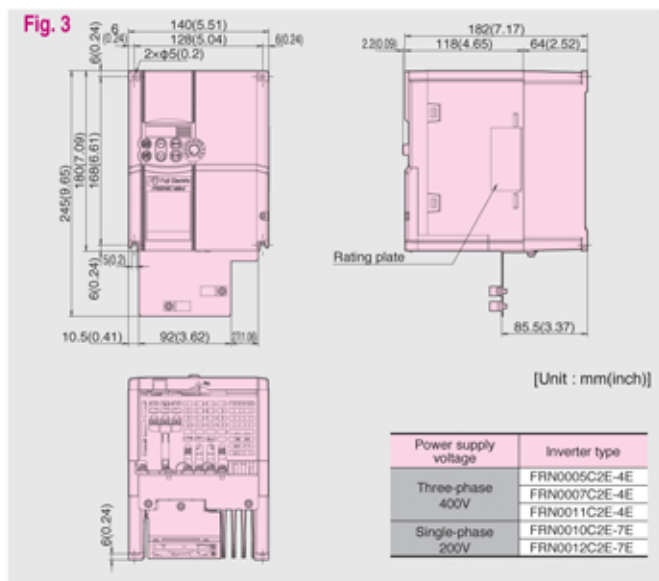
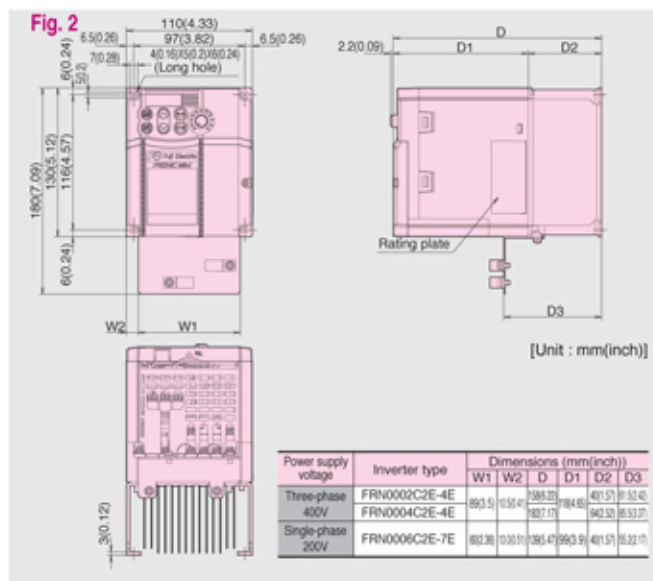
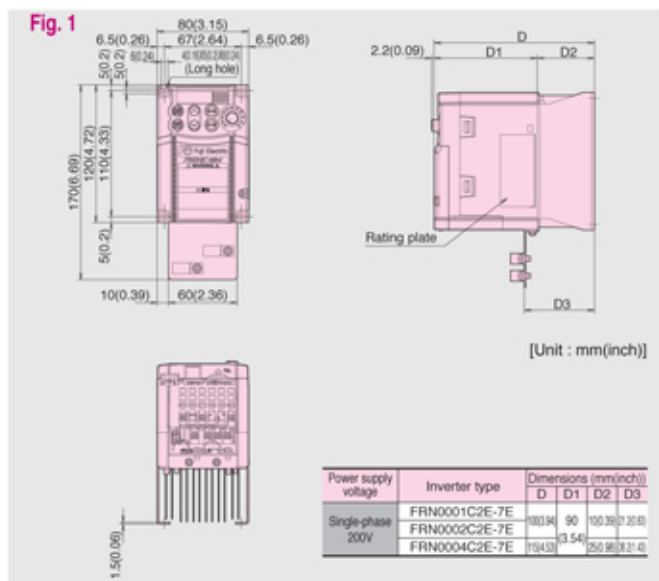

Features

Specifications

Terminal Functions

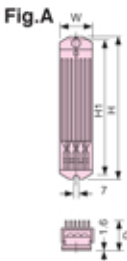
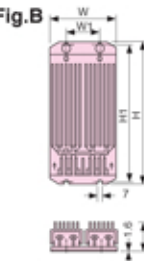
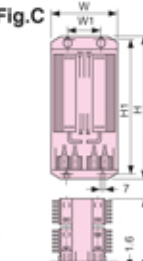
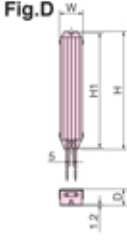
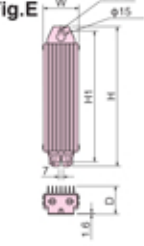
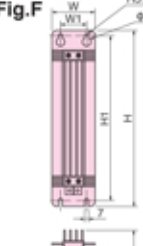

External Dimensions

Options

Name(Type)	Specifications and dimensions						[Unit:mm]				
Braking resistor [Standard] (DB□□□-2) (DB□□□-4) [10%ED type] (DB□□□-2C) (DB□□□-4C)	Fig.A	Fig.B	Fig.C	Type		Fig.	Dimensions [mm]				Mass [kg]
	200V		400V		W		H	H1	D		
				DB0.75-2	DB0.75-4	A	68	310	295	67	1.3
				DB2.2-2	-	A	80	345	332	94	2.0
				-	DB2.2-4	A	68	470	455	67	2.0
				DB3.7-2	-	A	80	345	332	94	2.0
				-	DB3.7-4	A	68	470	455	67	1.7
				DB5.5-2	-	B	146	450	430	67.5	4.5
				-	DB5.5-4	B	146	470	455	67	4.5
				DB7.5-2	-	B	160	390	370	90	5.0
				-	DB7.5-4	B	146	510	495	67	5.0
				DB11-2	-	C	142	430	415	160	6.9
				-	DB11-4	C	142	430	415	160	6.9
				DB15-2	-	C	142	430	415	160	6.9
				-	DB15-4	C	142	430	415	160	6.9
	Fig.D	Fig.E	Fig.F	Type		Fig.	Dimensions [mm]				Mass [kg]
200V		400V		W	H		H1	D			
				DB0.75-2C	DB0.75-4C	D	43	221	215	30.5	0.4
				DB2.2-2C	DB2.2-4C	E	67	188	172	55	0.8
				DB3.7-2C	DB3.7-4C	E	67	328	312	55	1.4
				DB5.5-2C	DB5.5-4C	E	80	378	362	78	-
				DB7.5-2C	DB7.5-4C	E	80	418	402	78	-
				DB11-2C	DB11-4C	F	80	460	440	140	-
				DB15-2C	DB15-4C	F	80	580	560	140	-

Type	Power supply voltage	Inverter type	Type	Q'ty	Resistance [Ω]	Max. braking torque [%]		Continuous braking (100% torque conversion value)		Repetitive braking (100 sec or less cycle)												
						50 [Hz]	60 [Hz]	Discharging capability [kWs]	Braking time [s]	Average loss [kW]	Duty cycle [%ED]											
						[N-m]	[N-m]															
Standard Type	Three-phase 200 V	FRN0004C2S-2□	DB0.75-2	1	100	150	4.02	3.32	9	45	0.044	22										
							7.57	6.25	17		0.068	18										
							15.0	12.4	34		0.075	10										
			DB2.2-2	1	40	150	22.0	18.2	33	30	0.077	7										
													DB3.7-2	1	33	37.1	30.5	37	0.093	5		
																					DB5.5-2	1
			DB7.5-2	1	15	75.1	61.9	37	0.188													
										DB11-2	1	10	110.2	90.8	55	0.275						
																	DB15-2	1	8.6	150.3	123.8	75
	Three-phase 400 V	FRN0004C2■-4□	DB0.75-4	1	200	150	4.02	3.32	9													
							7.57	6.25	17	0.068	18											
							15.0	12.4	34	0.075	10											
		DB2.2-4	1	160	150	22.0	18.2	33	30	0.077	7											
												DB3.7-4	1	130	37.1	30.5	37	0.093	5			
																				DB5.5-4	1	80
		DB7.5-4	1	60	75.1	61.9	38	0.188														
									DB11-4	1	40	110.2	90.8	55	0.275							
																DB15-4	1	34.4	150.3	123.8	75	0.375
Single-phase 200 V	FRN0004C2■-7□	DB0.75-2	1	100	150	4.02	3.32	9														
						7.57	6.25	17	0.068	18												
						15.0	12.4	34	0.075	10												
	DB2.2-2	1	40	150	22.0	18.2	33	30	0.077	7												
											Single-phase 100 V	FRN0004C2■-7□	DB0.75-2	1	100	150	4.02	3.32	9	45	0.044	22
																	7.57	6.25	17		0.068	18
	15.0	12.4	34	0.075	10																	
	DB2.2-2	1	40	150	22.0	18.2	33	30	0.077	7												

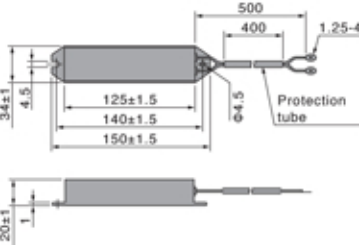
Note: 1) A box (□) in the above table replaces A, C, E, or U depending on shipping destination.
 2) A box (■) in the above table replaces S (Basic type) or E (EMC filter built-in type) depending on the enclosure.

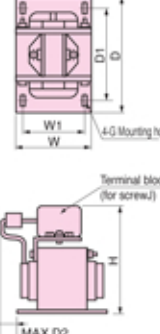
Name(Type)	Specifications and dimensions		[Unit:mm]																																																																																																																																																																																																																																																																																								
Braking resistor [Compact type] (TK80W120Ω) 		<table border="1"> <thead> <tr> <th>Power supply voltage</th> <th>Type</th> <th colspan="5">TK80W120Ω</th> </tr> </thead> <tbody> <tr> <td rowspan="2">200V class</td> <td>Resistor</td> <td>Capacity [kW]</td> <td colspan="5">0.08</td> </tr> <tr> <td></td> <td>Resistance [Ω]</td> <td colspan="5">120</td> </tr> <tr> <td rowspan="5">class</td> <td>Applicable inverter model</td> <td>FRN0004 C2-2</td> <td>FRN0006 C2-2</td> <td>FRN0010 C2-2</td> <td>FRN0012 C2-2</td> <td>FRN0020 C2-2</td> </tr> <tr> <td>Applicable motor output [kW]</td> <td>0.4</td> <td>0.75</td> <td>1.5</td> <td>2.2</td> <td>3.7, 4.0</td> </tr> <tr> <td>Average braking torque [%]</td> <td>150</td> <td>150</td> <td>150</td> <td>100</td> <td>100</td> </tr> <tr> <td>Allowable braking properties</td> <td>Allowable duty cycle [%]</td> <td>15</td> <td>5</td> <td>5</td> <td>5</td> <td>5</td> </tr> <tr> <td></td> <td>Allowable continuous braking time</td> <td>15sec</td> <td>15sec</td> <td>10sec</td> <td>10sec</td> <td>10sec</td> </tr> <tr> <td></td> <td>Braking unit</td> <td colspan="5">Not required</td> </tr> </tbody> </table>	Power supply voltage	Type	TK80W120Ω					200V class	Resistor	Capacity [kW]	0.08						Resistance [Ω]	120					class	Applicable inverter model	FRN0004 C2-2	FRN0006 C2-2	FRN0010 C2-2	FRN0012 C2-2	FRN0020 C2-2	Applicable motor output [kW]	0.4	0.75	1.5	2.2	3.7, 4.0	Average braking torque [%]	150	150	150	100	100	Allowable braking properties	Allowable duty cycle [%]	15	5	5	5	5		Allowable continuous braking time	15sec	15sec	10sec	10sec	10sec		Braking unit	Not required					<p>NOTE: This type of braking resistors is not applicable to the 400 V class series of inverters or to inverters of 5.5 kW (7.5 HP) or above.</p>																																																																																																																																																																																																																										
Power supply voltage	Type	TK80W120Ω																																																																																																																																																																																																																																																																																									
200V class	Resistor	Capacity [kW]	0.08																																																																																																																																																																																																																																																																																								
		Resistance [Ω]	120																																																																																																																																																																																																																																																																																								
class	Applicable inverter model	FRN0004 C2-2	FRN0006 C2-2	FRN0010 C2-2	FRN0012 C2-2	FRN0020 C2-2																																																																																																																																																																																																																																																																																					
	Applicable motor output [kW]	0.4	0.75	1.5	2.2	3.7, 4.0																																																																																																																																																																																																																																																																																					
	Average braking torque [%]	150	150	150	100	100																																																																																																																																																																																																																																																																																					
	Allowable braking properties	Allowable duty cycle [%]	15	5	5	5	5																																																																																																																																																																																																																																																																																				
		Allowable continuous braking time	15sec	15sec	10sec	10sec	10sec																																																																																																																																																																																																																																																																																				
	Braking unit	Not required																																																																																																																																																																																																																																																																																									
DC REACTOR (DCR2-□□□) (DCR4-□□□) 		<table border="1"> <thead> <tr> <th rowspan="2">Inverter type</th> <th rowspan="2">Reactor type</th> <th colspan="7">Dimensions</th> <th rowspan="2">Mass [kg]</th> </tr> <tr> <th>W</th> <th>W1</th> <th>D</th> <th>D1</th> <th>D2</th> <th>G</th> <th>H</th> <th>J</th> </tr> </thead> <tbody> <tr> <td>Three-phase 200V</td> <td></td> <td></td> <td></td> <td></td> <td></td> <td></td> <td></td> <td></td> <td></td> <td></td> </tr> <tr> <td>FRN0001C2S-2</td> <td>FRN0001C2-7</td> <td>DCR2-0.2</td> <td>66</td> <td>56</td> <td>90</td> <td>72</td> <td>5</td> <td>M4(5.2x8)</td> <td>94</td> <td>M4</td> <td>0.8</td> </tr> <tr> <td>FRN0002C2S-2</td> <td>FRN0002C2-7</td> <td>DCR2-0.4</td> <td>66</td> <td>56</td> <td>90</td> <td>72</td> <td>15</td> <td>M4(5.2x8)</td> <td>94</td> <td>M4</td> <td>1.0</td> </tr> <tr> <td>FRN0004C2S-2</td> <td>FRN0004C2-7</td> <td>DCR2-0.75</td> <td>66</td> <td>56</td> <td>90</td> <td>72</td> <td>20</td> <td>M4(5.2x8)</td> <td>94</td> <td>M4</td> <td>1.4</td> </tr> <tr> <td>FRN0006C2S-2</td> <td>FRN0006C2-7</td> <td>DCR2-1.5</td> <td>66</td> <td>56</td> <td>90</td> <td>72</td> <td>20</td> <td>M4(5.2x8)</td> <td>94</td> <td>M4</td> <td>1.6</td> </tr> <tr> <td>FRN0010C2S-2</td> <td>FRN0010C2S-6U</td> <td>DCR2-2.2</td> <td>86</td> <td>71</td> <td>100</td> <td>80</td> <td>10</td> <td>M5(6x9)</td> <td>110</td> <td>M4</td> <td>1.8</td> </tr> <tr> <td>FRN0012C2S-2</td> <td>FRN0003C2S-6U</td> <td>DCR2-3.7</td> <td>86</td> <td>71</td> <td>100</td> <td>80</td> <td>20</td> <td>M5(6x9)</td> <td>110</td> <td>M4</td> <td>2.6</td> </tr> <tr> <td>FRN0020C2S-2</td> <td>FRN0010C2-7</td> <td>DCR2-5.5</td> <td>111</td> <td>95</td> <td>100</td> <td>80</td> <td>20</td> <td>M6(7x11)</td> <td>130</td> <td>M5</td> <td>3.6</td> </tr> <tr> <td>FRN0025C2S-2</td> <td>FRN0012C2-7</td> <td>DCR2-7.5</td> <td>111</td> <td>95</td> <td>100</td> <td>80</td> <td>23</td> <td>M6(7x11)</td> <td>130</td> <td>M5</td> <td>3.8</td> </tr> <tr> <td>FRN0033C2S-2</td> <td></td> <td>DCR2-11</td> <td>111</td> <td>95</td> <td>100</td> <td>80</td> <td>24</td> <td>M6(7x11)</td> <td>137</td> <td>M6</td> <td>4.3</td> </tr> <tr> <td>FRN0047C2S-2</td> <td></td> <td>DCR2-15</td> <td>146</td> <td>124</td> <td>120</td> <td>96</td> <td>15</td> <td>M6(7x11)</td> <td>180</td> <td>M8</td> <td>5.9</td> </tr> <tr> <td>FRN0060C2S-2</td> <td></td> <td></td> <td></td> <td></td> <td></td> <td></td> <td></td> <td></td> <td></td> <td></td> <td></td> </tr> <tr> <td>Three-phase 400V</td> <td></td> <td></td> <td></td> <td></td> <td></td> <td></td> <td></td> <td></td> <td></td> <td></td> </tr> <tr> <td>FRN0002C2-4</td> <td></td> <td>DCR4-0.4</td> <td>66</td> <td>56</td> <td>90</td> <td>72</td> <td>15</td> <td>M4(5.2x8)</td> <td>94</td> <td>M4</td> <td>1.0</td> </tr> <tr> <td>FRN0004C2-4</td> <td></td> <td>DCR4-0.75</td> <td>66</td> <td>56</td> <td>90</td> <td>72</td> <td>20</td> <td>M4(5.2x8)</td> <td>94</td> <td>M4</td> <td>1.4</td> </tr> <tr> <td>FRN0005C2-4</td> <td></td> <td>DCR4-1.5</td> <td>66</td> <td>56</td> <td>90</td> <td>72</td> <td>20</td> <td>M4(5.2x8)</td> <td>94</td> <td>M4</td> <td>1.6</td> </tr> <tr> <td>FRN0007C2-4</td> <td></td> <td>DCR4-2.2</td> <td>86</td> <td>71</td> <td>100</td> <td>80</td> <td>15</td> <td>M5(6x9)</td> <td>110</td> <td>M4</td> <td>2.0</td> </tr> <tr> <td>FRN0011C2-4</td> <td></td> <td>DCR4-3.7</td> <td>86</td> <td>71</td> <td>100</td> <td>80</td> <td>20</td> <td>M5(6x9)</td> <td>110</td> <td>M4</td> <td>2.6</td> </tr> <tr> <td>FRN0013C2-4</td> <td></td> <td>DCR4-5.5</td> <td>86</td> <td>71</td> <td>100</td> <td>80</td> <td>20</td> <td>M5(6x9)</td> <td>110</td> <td>M4</td> <td>2.6</td> </tr> <tr> <td>FRN0018C2-4</td> <td></td> <td>DCR4-7.5</td> <td>111</td> <td>95</td> <td>100</td> <td>80</td> <td>24</td> <td>M6(7x11)</td> <td>130</td> <td>M5</td> <td>4.2</td> </tr> <tr> <td>FRN0024C2-4</td> <td></td> <td>DCR4-11</td> <td>111</td> <td>95</td> <td>100</td> <td>80</td> <td>24</td> <td>M6(7x11)</td> <td>130</td> <td>M5</td> <td>4.3</td> </tr> <tr> <td>FRN0030C2-4</td> <td></td> <td>DCR4-15</td> <td>146</td> <td>124</td> <td>120</td> <td>96</td> <td>15</td> <td>M6(7x11)</td> <td>168</td> <td>M5</td> <td>5.9</td> </tr> </tbody> </table>	Inverter type	Reactor type	Dimensions							Mass [kg]	W	W1	D	D1	D2	G	H	J	Three-phase 200V											FRN0001C2S-2	FRN0001C2-7	DCR2-0.2	66	56	90	72	5	M4(5.2x8)	94	M4	0.8	FRN0002C2S-2	FRN0002C2-7	DCR2-0.4	66	56	90	72	15	M4(5.2x8)	94	M4	1.0	FRN0004C2S-2	FRN0004C2-7	DCR2-0.75	66	56	90	72	20	M4(5.2x8)	94	M4	1.4	FRN0006C2S-2	FRN0006C2-7	DCR2-1.5	66	56	90	72	20	M4(5.2x8)	94	M4	1.6	FRN0010C2S-2	FRN0010C2S-6U	DCR2-2.2	86	71	100	80	10	M5(6x9)	110	M4	1.8	FRN0012C2S-2	FRN0003C2S-6U	DCR2-3.7	86	71	100	80	20	M5(6x9)	110	M4	2.6	FRN0020C2S-2	FRN0010C2-7	DCR2-5.5	111	95	100	80	20	M6(7x11)	130	M5	3.6	FRN0025C2S-2	FRN0012C2-7	DCR2-7.5	111	95	100	80	23	M6(7x11)	130	M5	3.8	FRN0033C2S-2		DCR2-11	111	95	100	80	24	M6(7x11)	137	M6	4.3	FRN0047C2S-2		DCR2-15	146	124	120	96	15	M6(7x11)	180	M8	5.9	FRN0060C2S-2												Three-phase 400V											FRN0002C2-4		DCR4-0.4	66	56	90	72	15	M4(5.2x8)	94	M4	1.0	FRN0004C2-4		DCR4-0.75	66	56	90	72	20	M4(5.2x8)	94	M4	1.4	FRN0005C2-4		DCR4-1.5	66	56	90	72	20	M4(5.2x8)	94	M4	1.6	FRN0007C2-4		DCR4-2.2	86	71	100	80	15	M5(6x9)	110	M4	2.0	FRN0011C2-4		DCR4-3.7	86	71	100	80	20	M5(6x9)	110	M4	2.6	FRN0013C2-4		DCR4-5.5	86	71	100	80	20	M5(6x9)	110	M4	2.6	FRN0018C2-4		DCR4-7.5	111	95	100	80	24	M6(7x11)	130	M5	4.2	FRN0024C2-4		DCR4-11	111	95	100	80	24	M6(7x11)	130	M5	4.3	FRN0030C2-4		DCR4-15	146	124	120	96	15	M6(7x11)	168	M5	5.9	<p>Note 1: Generated losses listed in the above table are approximate values that are calculated according to the following conditions: - The power source is 3-phase 200 V/400 V 50 Hz with 0% interphase voltage unbalance ratio. - The power source capacity uses the larger of either 500 kVA or 10 times the rated capacity of the inverter. - The motor is a 4-pole standard model at full load (100%). - An AC reactor (ACR) is not connected.</p> <p>Note 2: A box (□) in the above table replaces A, C, E, or U depending on shipping destination.</p> <p>Note 3: A box (■) in the above table replaces S (Basic type) or E (EMC filter built-in type) depending on the enclosure.</p>
Inverter type	Reactor type	Dimensions							Mass [kg]																																																																																																																																																																																																																																																																																		
		W	W1	D	D1	D2	G	H		J																																																																																																																																																																																																																																																																																	
Three-phase 200V																																																																																																																																																																																																																																																																																											
FRN0001C2S-2	FRN0001C2-7	DCR2-0.2	66	56	90	72	5	M4(5.2x8)	94	M4	0.8																																																																																																																																																																																																																																																																																
FRN0002C2S-2	FRN0002C2-7	DCR2-0.4	66	56	90	72	15	M4(5.2x8)	94	M4	1.0																																																																																																																																																																																																																																																																																
FRN0004C2S-2	FRN0004C2-7	DCR2-0.75	66	56	90	72	20	M4(5.2x8)	94	M4	1.4																																																																																																																																																																																																																																																																																
FRN0006C2S-2	FRN0006C2-7	DCR2-1.5	66	56	90	72	20	M4(5.2x8)	94	M4	1.6																																																																																																																																																																																																																																																																																
FRN0010C2S-2	FRN0010C2S-6U	DCR2-2.2	86	71	100	80	10	M5(6x9)	110	M4	1.8																																																																																																																																																																																																																																																																																
FRN0012C2S-2	FRN0003C2S-6U	DCR2-3.7	86	71	100	80	20	M5(6x9)	110	M4	2.6																																																																																																																																																																																																																																																																																
FRN0020C2S-2	FRN0010C2-7	DCR2-5.5	111	95	100	80	20	M6(7x11)	130	M5	3.6																																																																																																																																																																																																																																																																																
FRN0025C2S-2	FRN0012C2-7	DCR2-7.5	111	95	100	80	23	M6(7x11)	130	M5	3.8																																																																																																																																																																																																																																																																																
FRN0033C2S-2		DCR2-11	111	95	100	80	24	M6(7x11)	137	M6	4.3																																																																																																																																																																																																																																																																																
FRN0047C2S-2		DCR2-15	146	124	120	96	15	M6(7x11)	180	M8	5.9																																																																																																																																																																																																																																																																																
FRN0060C2S-2																																																																																																																																																																																																																																																																																											
Three-phase 400V																																																																																																																																																																																																																																																																																											
FRN0002C2-4		DCR4-0.4	66	56	90	72	15	M4(5.2x8)	94	M4	1.0																																																																																																																																																																																																																																																																																
FRN0004C2-4		DCR4-0.75	66	56	90	72	20	M4(5.2x8)	94	M4	1.4																																																																																																																																																																																																																																																																																
FRN0005C2-4		DCR4-1.5	66	56	90	72	20	M4(5.2x8)	94	M4	1.6																																																																																																																																																																																																																																																																																
FRN0007C2-4		DCR4-2.2	86	71	100	80	15	M5(6x9)	110	M4	2.0																																																																																																																																																																																																																																																																																
FRN0011C2-4		DCR4-3.7	86	71	100	80	20	M5(6x9)	110	M4	2.6																																																																																																																																																																																																																																																																																
FRN0013C2-4		DCR4-5.5	86	71	100	80	20	M5(6x9)	110	M4	2.6																																																																																																																																																																																																																																																																																
FRN0018C2-4		DCR4-7.5	111	95	100	80	24	M6(7x11)	130	M5	4.2																																																																																																																																																																																																																																																																																
FRN0024C2-4		DCR4-11	111	95	100	80	24	M6(7x11)	130	M5	4.3																																																																																																																																																																																																																																																																																
FRN0030C2-4		DCR4-15	146	124	120	96	15	M6(7x11)	168	M5	5.9																																																																																																																																																																																																																																																																																

Options

Remote keypad (TP-E1)

The keypad permits remote control of FRENIC-Mini, and function setting and display (with copy function).



USB-equipped remote keypad (TP-E1U)

Using the keypad in combination with FRENIC Loader enables a variety of data about the inverter unit to be saved in the keypad memory, allowing you to check the information in any place.

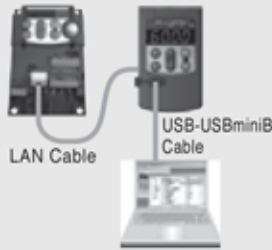

Remote operation extension cable (CB-□S)

This straight cable is used to connect the RS485 Communications card and the remote keypad, and available in three lengths, i.e. 1m, 3m and 5m.



Type	L(m)
CB-5S	5
CB-3S	3
CB-1S	1

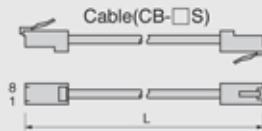

Rail mounting bases (RMA-C1-□□□)

A rail mounting base allows any of the FRENIC-Mini series of inverter to be mounted on a DIN rail (35 mm (1.38 inches) wide).

Option model	Applicable inverter type
RMA-C1-0.75	FRN0001C2S-2 <input type="checkbox"/>
	FRN0002C2S-2 <input type="checkbox"/>
	FRN0004C2S-2 <input type="checkbox"/>
	FRN0006C2S-2 <input type="checkbox"/>
	FRN0001C2S-7 <input type="checkbox"/>
	FRN0002C2S-7 <input type="checkbox"/>
	FRN0004C2S-7 <input type="checkbox"/>
	FRN0006C2S-7 <input type="checkbox"/>
	FRN0001C2S-6U <input type="checkbox"/>
	FRN0002C2S-6U <input type="checkbox"/>
FRN0003C2S-6U <input type="checkbox"/>	
FRN0001C2E-7 <input type="checkbox"/>	
FRN0002C2E-7 <input type="checkbox"/>	
FRN0004C2E-7 <input type="checkbox"/>	
RMA-C1-2.2	FRN0010C2S-2 <input type="checkbox"/>
	FRN0012C2S-2 <input type="checkbox"/>
	FRN0002C2S-4 <input type="checkbox"/>
	FRN0004C2S-4 <input type="checkbox"/>
	FRN0005C2S-4 <input type="checkbox"/>
	FRN0007C2S-4 <input type="checkbox"/>
	FRN0010C2S-7 <input type="checkbox"/>
	FRN0002C2E-4 <input type="checkbox"/>
	FRN0004C2E-4 <input type="checkbox"/>
	FRN0006C2E-7 <input type="checkbox"/>
FRN0020C2S-2 <input type="checkbox"/>	
RMA-C1-3.7	FRN0011C2S-4 <input type="checkbox"/>
	FRN0012C2S-7 <input type="checkbox"/>
	FRN0005C2E-4 <input type="checkbox"/>
	FRN0007C2E-4 <input type="checkbox"/>
	FRN0011C2E-4 <input type="checkbox"/>
	FRN0010C2E-7 <input type="checkbox"/>
	FRN0012C2E-7 <input type="checkbox"/>

Mounting adapters (MA-C1-□□□)

FRENIC-Mini series of inverters can be installed in the control board of your system using mounting adapters which utilize the mounting holes used for conventional inverters (FVR-E11S series of 0.75 kW or below or 3.7 (4.0) kW). The FVR-E11S-2/4 (1.5 kW/2.2 kW) and FVR-E11S-7 (0.75 kW/1.5 kW) models may be replaced with the FRENIC-Mini series inverters without the use of adapters.

Option model	Applicable inverter model	
	FRENIC-Mini	FVR-E11S
MA-C1-0.75	FRN0001C2S-2 <input type="checkbox"/>	FVR0.1E11S-2 <input type="checkbox"/>
	FRN0002C2S-2 <input type="checkbox"/>	FVR0.2E11S-2 <input type="checkbox"/>
	FRN0004C2S-2 <input type="checkbox"/>	FVR0.4E11S-2 <input type="checkbox"/>
	FRN0006C2S-2 <input type="checkbox"/>	FVR0.75E11S-2 <input type="checkbox"/>
	FRN0001C2S-7 <input type="checkbox"/>	FVR0.1E11S-7 <input type="checkbox"/>
	FRN0002C2S-7 <input type="checkbox"/>	FVR0.2E11S-7 <input type="checkbox"/>
MA-C1-3.7	FRN0004C2S-7 <input type="checkbox"/>	FVR0.4E11S-7 <input type="checkbox"/>
	FRN0006C2S-7 <input type="checkbox"/>	FVR0.75E11S-7 <input type="checkbox"/>
	FRN0020C2S-2 <input type="checkbox"/>	FVR3.7E11S-2 <input type="checkbox"/>
	FRN0011C2S-4 <input type="checkbox"/>	FVR3.7E11S-4 <input type="checkbox"/>
	FRN0012C2S-7 <input type="checkbox"/>	FVR4.0E11S-4 <input type="checkbox"/>
		FVR2.2E11S-7 <input type="checkbox"/>

Note: A box (□) in the above table replaces A, C, E, or U depending on shipping destination.

Note 1: A box (□) in the above table replaces A, C, E, or U depending on shipping destination.

Note 2: This rail mounting base is not suitable for the inverters of 5.5 kW (7.5 HP) or above.

NEMA1 kit (NEMA1-□□□C2-□)

Mounting the NEMA1 kit on the FRENIC-Mini series of inverters brings the inverter's enclosure into compliance with the NEMA1 Standard (UL TYPE1 certified).

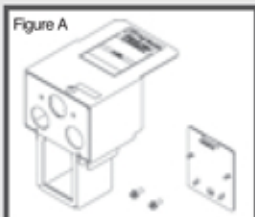
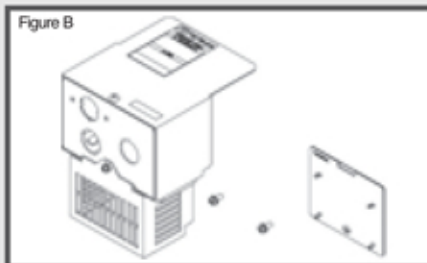

Power supply voltage	Inverter type	Option type	Figure	
Three-phase 200 V	FRN0001C2S-2 <input type="checkbox"/>	NEMA1-C2-101	A	
	FRN0002C2S-2 <input type="checkbox"/>			
	FRN0004C2S-2 <input type="checkbox"/>			
	FRN0006C2S-2 <input type="checkbox"/>	NEMA1-C2-102		
	FRN0010C2S-2 <input type="checkbox"/>	NEMA1-C2-103		
Three-phase 400 V	FRN0010C2S-2 <input type="checkbox"/>	NEMA1-C2-201	B	
	FRN0012C2S-2 <input type="checkbox"/>	NEMA1-C2-301	C	
	FRN0020C2S-2 <input type="checkbox"/>			
	FRN0002C2S-4 <input type="checkbox"/>			NEMA1-C2-202
	FRN0004C2S-4 <input type="checkbox"/>	NEMA1-C2-203		
Single-phase 200 V	FRN0005C2S-4 <input type="checkbox"/>	NEMA1-C2-201		B
	FRN0007C2S-4 <input type="checkbox"/>	NEMA1-C2-301	C	
	FRN0011C2S-4 <input type="checkbox"/>			
	FRN0001C2S-7 <input type="checkbox"/>			NEMA1-C2-101
	FRN0002C2S-7 <input type="checkbox"/>	NEMA1-C2-102		A
FRN0004C2S-7 <input type="checkbox"/>				
FRN0006C2S-7 <input type="checkbox"/>				
Single-phase 100 V	FRN0001C2S-6U <input type="checkbox"/>	NEMA1-C2-104	A	
	FRN0002C2S-6U <input type="checkbox"/>	NEMA1-C2-105		
	FRN0003C2S-6U <input type="checkbox"/>	NEMA1-C2-106		
	FRN0005C2S-6U <input type="checkbox"/>	NEMA1-C2-204		
		NEMA1-C2-205		

This option is not applicable to the EMC filter built-in type or inverters of 5.5 kW or above.

■ Wiring equipment

Power supply voltage	Applicable motor rating [kW]	Inverter type	MCCB, ELCB Rated current [A]		Magnetic contactor type MC1 (for input circuit)		Magnetic contactor type MC2 (for output circuit)	Recommended wire size (mm ²) at 50°C (122°F) or below				
			DC reactor (DCR)		DC reactor (DCR)			Main circuit power input [L1/R, L2/S, L3/T] or [L1/L, L2/N]		Inverter output [U, V, W]	DC reactor [P1, P(+)]	Braking resistor [P(+), DB]
			w/ DCR	w/o DCR	w/ DCR	w/o DCR		w/ DC reactor (DCR)	w/o DC reactor (DCR)			
Three-phase 200 V	0.1	FRN0001C2S-2	5 (6)	5 (6)	SC-05	SC-05	SC-05	2.0 (2.5)	2.0 (2.5)	2.0 (2.5)	2.0(2.5)	-
	0.2	FRN0002C2S-2										-
	0.4	FRN0004C2S-2	10	15 (16)	SC-05	SC-05	SC-05	2.0 (2.5)	2.0 (2.5)	2.0 (2.5)	2.0(2.5)	2.0 (2.5)
	0.75	FRN0006C2S-2										10
	1.5	FRN0010C2S-2	20 (25)	30 (35)	SC-4-0	SC-5-1	SC-4-0	5.5 (6)	5.5 (6)	3.5 (4)	3.5 (4.0)	-
	2.2	FRN0012C2S-2										20 (25)
	3.7	FRN0020C2S-2	30 (35)	50	SC-4-0	SC-5-1	SC-4-0	5.5 (6)	5.5 (6)	3.5 (4)	3.5 (4.0)	-
	5.5	FRN0025C2S-2										30 (35)
	7.5	FRN0033C2S-2	40	75	SC-5-1	SC-N1	SC-5-1	8 (10)	14 (16)	8 (10)	14 (16)	-
	11	FRN0047C2S-2										40
15	FRN0060C2S-2	50	100	SC-N1	SC-N2S	SC-N1	14 (16)	22 (25)	14 (16)	22 (25)	-	
15	FRN0060C2S-2	75	125	SC-N2	SC-N3	SC-N2	22 (25)	38 (50)	22 (25)	38 (50)	-	
Three-phase 400 V	0.4	FRN0002C2-4	5 (6)	5 (6)	SC-05	SC-05	SC-05	2.0 (2.5)	2.0 (2.5)	2.0 (2.5)	2.0 (2.5)	2.0 (2.5)
	0.75	FRN0004C2-4										-
	1.5	FRN0005C2-4	10	15 (16)	SC-05	SC-05	SC-05	2.0 (2.5)	2.0 (2.5)	2.0 (2.5)	2.0 (2.5)	-
	2.2	FRN0007C2-4										10
	3.7/4.0	FRN0011C2-4	20 (25)	30 (35)	SC-4-0	SC-N1	SC-4-0	5.5 (6)	5.5 (6)	3.5 (4)	3.5 (4)	-
	5.5	FRN0013C2-4										20 (25)
	7.5	FRN0018C2-4	30 (35)	50	SC-4-0	SC-N1	SC-4-0	5.5 (6)	8 (10)	5.5 (6)	5.5 (6)	-
	11	FRN0024C2-4										30 (35)
15	FRN0030C2-4	40	60	SC-5-1	SC-N3	SC-5-1	8 (10)	14 (16)	8 (10)	14 (16)	-	
Single-phase 200 V	0.1	FRN0001C2-7	5 (6)	5 (6)	SC-05	SC-05	SC-05	2.0 (2.5)	2.0 (2.5)	2.0 (2.5)	2.0 (2.5)	-
	0.2	FRN0002C2-7										-
	0.4	FRN0004C2-7	10	15 (16)	SC-05	SC-05	SC-05	2.0 (2.5)	2.0 (2.5)	2.0 (2.5)	2.0 (2.5)	2.0 (2.5)
	0.75	FRN0006C2-7										10
	1.5	FRN0010C2-7	20 (25)	30 (35)	SC-05	SC-5-1	SC-05	3.5 (4.0)	5.5 (6.0)	3.5 (4.0)	3.5 (4.0)	-
	2.2	FRN0012C2-7										20 (25)
Single-phase 100 V	0.1	FRN0001C2S-6U	5 (6)	5 (6)	SC-05	SC-05	SC-05	2.0 (2.5)	2.0 (2.5)	2.0 (2.5)	-	-
	0.2	FRN0002C2S-6U										-
	0.4	FRN0003C2S-6U	10	15 (16)	-	-	-	2.0 (2.5)	-	-	-	2.0 (2.5)
0.75	FRN0005C2S-6U	15 (16)	20 (25)	-	-	-	3.5 (4.0)	-	-	-	-	-

Note) The symbol ■ is replaced with either of the following letters ■: S (Standard type), E (EMC filter built-in type)

- For molded-case circuit breakers (MCCB) and earth-leakage circuit breakers (ELCB), the required frame type and series depend on the facility transformer capacity and other factors. When selecting optimal breakers, refer to the relevant technical data. Also select the rated sensitive current of ELCB utilizing the technical data.
- The recommended wire sizes are based on the temperature inside the panel not exceeding 50°C.
- The above wires are 600V HIV insulated solid wires (75°C).
- Data in the above table may differ according to environmental conditions (ambient temperature, power supply voltage, and other factors).

MEMO

MEMO



NOTES

When running general-purpose motors

• Driving a 400V general-purpose motor

When driving a 400V general-purpose motor with an inverter using extremely long cables, damage to the insulation of the motor may occur. Use an output circuit filter (OFL) if necessary after checking with the motor manufacturer. Fuji's motors do not require the use of output circuit filters because of their reinforced insulation.

• Torque characteristics and temperature rise

When the inverter is used to run a general-purpose motor, the temperature of the motor becomes higher than when it is operated using a commercial power supply. In the low-speed range, the cooling effect will be weakened, so decrease the output torque of the motor. If constant torque is required in the low-speed range, use a Fuji inverter motor or a motor equipped with an externally powered ventilating fan.

• Vibration

When the motor is mounted to a machine, resonance may be caused by the natural frequencies, including that of the machine. Operation of a 2-pole motor at 60Hz or more may cause abnormal vibration.

* Study use of tier coupling or dampening rubber.

* It is also recommended to use the inverter jump frequencies control to avoid resonance points.

• Noise

When an inverter is used with a general-purpose motor, the motor noise level is higher than that with a commercial power supply. To reduce noise, raise carrier frequency of the inverter. High-speed operation at 60Hz or more can also result in more noise.

When running special motors

• Explosion-proof motors

When driving an explosion-proof motor with an inverter, use a combination of a motor and an inverter that has been approved in advance.

• Brake motors

For motors equipped with parallel-connected brakes, their braking power must be supplied from the primary circuit (commercial power supply). If the brake power is connected to the inverter power output circuit (secondary circuit) by mistake, problems may occur.

Do not use inverters for driving motors equipped with series-connected brakes.

• Geared motors

If the power transmission mechanism uses an oil-lubricated gearbox or speed changer/reducer, then continuous motor operation at low speed may cause poor lubrication. Avoid such operation.

• Single-phase motors

Single-phase motors are not suitable for inverter-driven variable speed operation. Use three-phase motors.

Environmental conditions

• Installation location

Use the inverter in a location with an ambient temperature range of -10°C (14°F) to 50°C (122°F). The inverter and braking resistor surfaces become hot under certain operating conditions. Install the inverter on nonflammable material such as metal. Ensure that the installation location meets the environmental conditions specified in "Environment" in inverter specifications.

Combination with peripheral devices

• Installing a molded case circuit breaker (MCCB)

Install a recommended molded case circuit breaker (MCCB) or an earth leakage circuit breaker (ELCB) in the primary circuit of each inverter to protect the wiring. Ensure that the circuit breaker capacity is equivalent to or lower than the recommended capacity.

• Installing a magnetic contactor (MC) in the output (secondary) circuit

If a magnetic contactor (MC) is mounted in the inverter's secondary circuit for switching the motor to commercial power or for any other purpose, ensure that both the inverter and the motor are fully stopped before you turn the MC on or off. Remove the surge killer integrated with the MC.

• Installing a magnetic contactor (MC) in the input (primary) circuit

Do not turn the magnetic contactor (MC) in the primary circuit on or off more than once an hour as an inverter fault may result. If frequent starts or stops are required during motor operation, use FWD/REV signals.

• Protecting the motor

The electronic thermal facility of the inverter can protect the general-purpose motor. The operation level and the motor type (general-purpose motor, inverter motor) should be set. For high-speed motors or water-cooled motors, set a small value for the thermal time constant to protect the motor.

If you connect the motor thermal relay to the motor with a long cable, a high-frequency current may flow into the wiring stray capacitance. This may cause the relay to trip at a current lower than the set value for the thermal relay. If this happens, lower the carrier frequency or use the output circuit filter (OFL).

• Discontinuance of power-factor correcting capacitor

Do not mount power factor correcting capacitors in the inverter (primary) circuit. (Use the DC REACTOR to improve the inverter power factor.) Do not use power factor correcting capacitors in the inverter output circuit (secondary). An overcurrent trip will occur, disabling motor operation.

• Discontinuance of surge killer

Do not mount surge killers in the inverter output (secondary) circuit.

• Reducing noise

Use of a filter and shielded wires are typical measures against noise to ensure that EMC Directives are met.

• Measures against surge currents

If an overvoltage trip occurs while the inverter is stopped or operated under a light load, it is assumed that the surge current is generated by open/close of the phase-advancing capacitor in the power system.

We recommend connecting a DC REACTOR to the inverter.

• Megger test

When checking the insulation resistance of the inverter, use a 500V megger and follow the instructions contained in the Instruction Manual.

Wiring

• Wiring distance of control circuit

When performing remote operation, use twisted shielded wire and limit the distance between the inverter and the control box to 20m (65.6ft).

• Wiring length between inverter and motor

If long wiring is used between the inverter and the motor, the inverter will overheat or trip as a result of overcurrent (high-frequency current flowing into the stray capacitance) in the wires connected to the phases. Ensure that the wiring is shorter than 50m (164ft). If this length must be exceeded, lower the carrier frequency or mount an output circuit filter (OFL).

When wiring is longer than 50m (164ft), and sensorless vector control or vector control with speed sensor is selected, execute off-line tuning.

• Wiring size

Select cables with a sufficient capacity by referring to the current value or recommended wire size.

• Wiring type

Do not use multicore cables that are normally used for connecting several inverters and motors.

• Grounding

Securely ground the inverter using the grounding terminal.

Selecting inverter capacity

• Driving general-purpose motor

Select an inverter according to the applicable motor ratings listed in the standard specifications table for the inverter. When high starting torque is required or quick acceleration or deceleration is required, select an inverter with a capacity one size greater than the standard.

• Driving special motors

Select an inverter that meets the following condition: Inverter rated current > Motor rated current.

Transportation and storage

When transporting or storing inverters, follow the procedures and select locations that meet the environmental conditions that agree with the inverter specifications.



UNIVERSAL ELECTRIC MOTORS

DIVISION of 1279311 ONTARIO INC.

TEL: (905)670-3380 FAX: (905)670-7637

TOLL FREE: 1-877-670-3380