



UNIVERSAL ELECTRIC MOTORS

COOLING MOTOR CATALOGUE

NEW THIS SEASON

- ✓ EXPANDED RANGE OF OEM REPLACEMENTS
- ✓ MORE ENERGY EFFICIENT MOTORS ADDED
- ✓ MANY NEW FAN COIL MOTORS
- ✓ NEW ECM OEM REPLACEMENTS
- ✓ 70°C AMBIENT 575 VOLT CONDENSER FAN MOTORS
- ✓ 575 VOLT 825 RPM CONDENSER FAN MOTORS
- ✓ EXTENDED RANGE OF VARIABLE SPEED DRIVES



OMNIDRIVE®



WE DO MOTORS BEST.



ECM Unit Bearing Motors

Energy Efficient Electronically Commutated Brushless DC Motors



www.uem.ca

New Product



Ultimate Truck Stock Motor™

Features:

- Suitable for Evaporator & Condenser Applications
- IP66 Water Tight with all angle Moisture Protection
- High Efficiency (up to 65%)
- Includes Plug, Speed Nut, Rubber Isolator
- Universal Mounting
- UL/CUL Approved
- Aluminum Frame
- Thermally Protected
- Robust Ball Bearing System
- Replaces: Hussmann, Copeland, Tecumseh, Hill, Tyler, Kysor, Crystal Tips & More..

4 to 25 Watts!



All Models



▲ Std 3-hole style
■ Hussmann 4-hole



Dual Side Bosses

Refrigeration ECM



Stock #	Encl.	Watts	Volts	Amps.	RPM Range	Bearings	Shaft	Rotation
New EC5411	IP66	4 - 25	115	0.20 - 0.75	1550 - 1775	Ball	Hubless	CWOSE
New EC5412	IP66	4 - 25	115	0.20 - 0.75	1550 - 1775	Ball	Hubless	CCWOSE

Cross Reference

	Rotom	Morrill	Century
EC5411	04-R6711, 04-R6811 04-R9211, 04-R5444	5R016, 5R024, 5R025, 5R020, 5R021	9207F2, 9208F2 9211, 9212, 9213
EC5412	Not Available	Not Available	Not Available

Kit Sold Separately



Converts 2-pin Straight to 2-pin 90 Degree



6 to 16 Watts!

Features:

- Cast Iron Construction
- Dual Side Bosses
- 2-pin Lyall Plug Included
- Up to 65% Efficiency
- Standard 3 Hole & 4 Hole (Husmann Style Mount)
- Replaces 6, 9, 12, 14, 15 & 16 Watt P.S.C. & Low Efficiency Shaded Pole Motors



All Models

Refrigeration ECM



Formerly A.O. Smith Electrical Products Company

Stock #	Encl.	Watts	Volts	Amps.	RPM	Shaft	Rotation	Replaces
9207F2	T.E.	6 - 9 - 12	115	0.20 - 0.30	1550	Hubless	CWOSE	R6711
9208F2	T.E.	14 - 15 - 16	115	0.47 - 0.58	1550	Hubless	CWOSE	R6811

Features:

- Up to 70% Efficiency
- Mounting Shroud & Fan Guard Mounting With Four Extended M4 Threaded Thru-Bolts on Motor Shaft Side
- Reduce Inventories, One Motor Covers 4W Through 16W Applications
- Energy & Cost Saving, Payback In Less Than One Year
- CO² Reduction, Eco-Friendly Technology
- Drop In Replacement For Traditional Shaded Pole Unit Bearing Motors
- ECR Motors Are Ideal For Retrofit & New Installations
- Clockwise Opposite Shaft End Rotation, 19" Sleeved Leads With 2 Pin Plug
- Rear Mounting With Three Standard 8-32 UNC Threaded Holes
- Foot Mounting With 4 Threaded 8-32 UNC Holes
- Universal Hubless Shaft Accommodates Standard Axial Fan Blades
- Moisture & Humidity Resistant
- Input Voltage Range For ECR161 Motor Is 90V...140V
- Operating Temperature Range of -10°C to +40°C (14°F to 104°F)
- Automatic Thermal Overload/Electronic Protection
- Fully Enclosed, Long Life Ball Bearings

4 to 16 Watts!



ECR161

Refrigeration ECM



Stock #	Encl.	Watts	Volts	Amps.	RPM	Shaft	Rotation	Replaces
ECR161 •	T.E.A.O.	16 Max.	115	0.34	1800	Hubless	CWOSE	Many OEM



Features:

- Open Fan Cooled
- Shaded Pole Design
- Sleeve and Ball Bearings



G.E. 11 Frame Replacements



Stock #	Encl.	HP	Volts	Amps.	RPM	Shaft	Rotation	Replaces
9660	O.F.C.	1/20	115	2.00	1550	5/16" x 2.00"	CWOSE	GE-1331
9661	O.F.C.	1/20	115	2.00	1550	5/16" x 2.00"	CCWOSE	GE-1341
9662	O.F.C.	1/20	208-230	1.00	1550	5/16" x 2.00"	CCWOSE	GE-1342
9663	O.F.C.	1/20	208-230	1.00	1550	5/16" x 1-1/4"	CWOSE	GE-1016
9664	O.F.C.	1/20	208-230	1.00	1550	5/16" x 2.00"	CWOSE	GE-1332
9336 •	O.F.C.	1/20	230	1.10	1550	5/16" x 2-5/8"	CWOSE	GE-1336
SS1332 •	O.F.C.	1/20	208-230	1.10	1550	5/16" x 2.00"	CCWSE	GE-1332
SS671 •	O.F.C.	1/15	115/208-230	2.10/1.10	1550	5/16" x 2.00"	CCWSE	GE-1231
SS672 •	O.F.C.	1/15	115/208-230	2.10/1.10	1550	5/16" x 2.00"	CWSE	GE-1441
9665	O.F.C.	1/15	208-230	1.00	1550	5/16" x 1-1/4"	CWOSE	GE-1232
671B •	O.F.C.	1/15	115/208-230	2.10/1.10	1550	5/16" x 2.00"	CWOSE	GE-1231
672B •	O.F.C.	1/15	115/208-230	2.10/1.10	1550	5/16" x 2.00"	CCWOSE	GE-1441
981	O.F.C.	1/15	460	0.60	1550	5/16" x 2-1/2"	CCWSE	810F050B

Pedestal Fan Air Circulator Motors

Features:

- Yoke Mount - Extended Through Bolts
- Totally Enclosed, Air Over
- Thermally Protected
- Pull Chain
- 10' Cord & Plug
- 40°C Ambient
- Sealed Ball Bearings



All Models

48 Frame - Two Speed



Stock #	Encl.	HP	Volts	Amps.	RPM	Shaft	Rotation	Replaces
SS486 •*	T.E.A.O.	1/4	115	3.40	1100 / 2	1/2" x 3.00"	REV.	General Replacement
SS647 •*	T.E.A.O.	1/3	115	4.40	1100 / 2	1/2" x 3.00"	REV.	General Replacement

Features:

- Shaded Pole Design
- Cast Iron Construction
- Totally Enclosed



All Models

Unit Bearings

OMNIDRIVE®	Stock #	Encl.	Watts	Volts	Amps.	RPM	Shaft	Rotation	Replaces
	SS5211	T.E.	4	115	0.29	1550	Hubless	CWLE	EE5211
	SS5311	T.E.	6	115	0.40	1550	Hubless	CWLE	EE5311
	SS5411	T.E.	9	115	0.55	1550	Hubless	CWLE	EE5411
	SS5611	T.E.	9	115	0.55	1550	Hubless	CWLE	EE5611
	SS5811	T.E.	16	115	1.00	1550	Hubless	CWLE	EE5811

Features:

- Shaded Pole Design
- Cast Iron Construction
- Open Enclosure



250 - 252 - 254 - 256

258 - 260

276

Unit Bearings

Century®	Stock #	Encl.	Watts	Volts	Amps.	RPM	Shaft	Rotation	Replaces
	250	O.O.S.E.	25	115	1.10	1500	Hubless	CWLE	R2511
	252	O.O.S.E.	25	230	0.60	1500	Hubless	CWLE	R2512
	254	O.O.S.E.	35	115	1.40	1500	Hubless	CWLE	R3511
	256	O.O.S.E.	35	230	0.70	1500	Hubless	CWLE	R3512
	258	O.O.S.E.	50	115	1.70	1500	3/8" x 1-1/2"	CWLE	R5011
	260	O.O.S.E.	50	230	0.85	1500	3/8" x 1-1/2"	CWLE	R5012
	276	O.S.E.	50	230	0.85	1500	5/16" x 2-1/2"	CCWLE	R5122



Features:

- Impedance or Thermally Protected
- Continuous Duty, Air Over
- Mechanically Reversible
- Class 'B' Insulation



'C' Frame Skeleton

SS617

SS635

SS3670

SS3100

OMNIDRIVE®

Stock #	Stack	Volts	Amps.	RPM	Shaft	Rotation	Replaces
SS617	3/8	208-240	0.22	1900	3/16" x 1-1/4"	CWSE	R617
SS635	1-1/2	208-240	1.20/0.83	1550	1/4" x 1-1/2"	CCWSE	R635
SS3670	5/8	120/240	0.40/0.26	3000	3/16" x 1-9/16"	CWSE	R3670
SS3100	5/8	115	0.59	3000	7/32" x 1-11/16"	CCWSE	R3100, C01550 EM550, VFM100 SM550, C65878

Evaporator Fan Motors



SS101 - SS103

SS313 - SS360 - SS368

SS358 - SS359

SS369

Features:

- Open & Totally Enclosed Construction
- Shaded Pole & P.S.C. Design
- Sleeve and Ball Bearings



SS370 - SS371

SS574 - SS575

SS9721

3.3" Diameter

OMNIDRIVE®

Stock #	Encl.	HP	Volts	Amps.	RPM	Shaft	Rotation	Replaces
SS101	T.E.	1/45	115	0.90	1550	Hubless	CCWSE	R101
SS103	T.E.	1/45	115	0.90	1550	Hubless	CWSE	R103
SS313 ●	OPEN	1/15	115	2.20	1550	5/16" x 3.00"	CWSE	R313
SS358	OPEN	1/20	115	2.00	1550	5/16" x 3.20"	CWSE	R358
SS359	OPEN	1/20	230	1.10	1550	5/16" x 3.20"	CWSE	R359
SS360	OPEN	1/30	115	1.20	1550	1/4" x 1.75"	CCWSE	R360
SS368	OPEN	1/20	115	1.80	1550	5/16" x 2.80"	CCWSE	R368
SS369	OPEN	1/20	230	0.95	1550	5/16" x 2.75"	CCWSE	R369
SS370 ●*	OPEN	1/20	115	0.80	1550	5/16" x 2.80"	CCWSE	R370
SS371 ●*	OPEN	1/20	230	0.30	1550	5/16" x 2.80"	CCWSE	R371
SS574	OPEN	1/20	120	1.90	1550	5/16" x 2.50"	CCWSE	R90574
SS575	OPEN	1/20	208-230	0.89	1550	5/16" x 2.50"	CCWSE	R90575
SS9721 ●*	OPEN	1/12	115/208-230	1.10 / 0.60	1550	5/16" x 3.15"	REV.	R90721



Ultimate Truck Stock Motor™

Features:

- High Efficiency P.S.C. Design
- Uses Over 40% Less Electricity than Shaded Pole Designs
- Four 8-32 x 3/4" Stud Extensions at each end
- Automatic Reset Thermal Overload Protector
- Capacitor Included
- Reversing Leads
- Ball Bearings have all Angle Thrust System
- 15" Cord & Plug (0.250" pin pitch) Includes Adapter for 0.375" pin pitch



All Models

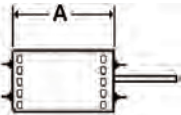

3.3" Diameter



Stock #	Incl.	HP	Volts	Amps.	RPM	"A" Dim.	Shaft	Rotation
New EM-9662 ●*	OPEN	1/20	115	0.85	1550	3.26"	5/16" x 3.00"	REV.
New EM-9656 ●*	OPEN	1/15	208-230	0.48	1550	3.78"	5/16" x 3.00"	REV.

Cross Reference

	Rotom	Bohn	Century	Fasco
EM-9662	R90721, R358, R1052, R368 R90572, R90574	5001L, 5008S, 5004L 5034L, 5034LS, 5008SS	574A, 574	D1124, D1101
EM-9656	R90721, R359, R1053, R369 R90573, R90575, R91125	7190-0442, 25309101 5008T, 5034M, 5034MS 5008TS	573A, 575	D1126, D1125, D1103 D1122, D1123

	Blanchard-Ness	Larkin	Packard	Ref Plus
EM-9662	E1052	253-1194, 25309101 7163-2113, JA2N015N	41101, 41154, 45036 41124, 45008S, 49101	RMT0011
EM-9656	E1053	253-1195, 25309101 7163-3371, 7163-2135 JA2N016N	41103, 41195, 41126 45008T, 41125, 49101	RMT0012

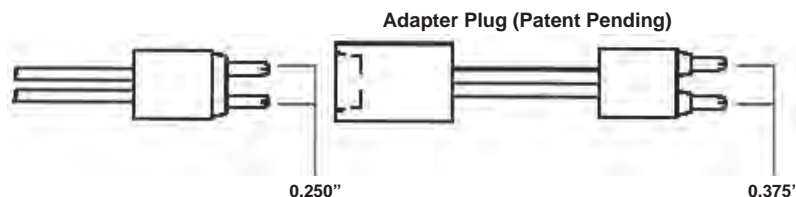

(●) Ball Bearing (*) P.S.C. Design



ECM Evaporator Fan Motors

Energy Efficient Electronically Commutated Brushless DC Motors

www.uem.ca

Features:

- Up to 70% Efficiency
- Energy & Cost Saving, Payback In Less Than One Year
- CO² Reduction, Eco-Friendly Technology
- Drop In Replacement For Traditional Shaded Pole & P.S.C. Evaporator Fan Motors
- Flexible Mounting With Four Extended 8-32 UNC Threaded Thru-Bolts on 2.84" B.C.D. at Both Ends
- Clockwise Shaft End Rotation, 19" Sleeved Leads With 2 Pin Plug
- Standard 5/16" Shaft Diameter, 2-1/2" Length With 1-3/4" Flat
- Moisture & Humidity Resistant, IP42 Enclosure Rating
- Operating Temperature Range of -30°C to +40°C (-22°F to 104°F)
- Input Voltage Range For ECR501 Motor is 100V...127V
ECR502 Motor is 190V...254V
- Fully Enclosed, Long Life Ball Bearings
- Automatic Thermal Overload/Electronic Protection

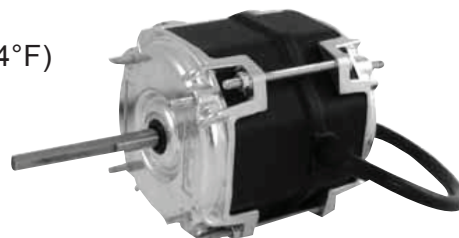

All Models

3.3" Diameter

OMNIDRIVE®	Stock #	Encl.	Watts	Volts	Amps.	RPM	Shaft	Rotation	Replaces
	ECR501	T.E.A.O.	50	115	1.13	1550	5/16" x 2-1/2"	CWSE	Many OEM
	ECR502	T.E.A.O.	50	208-230	0.67	1550	5/16" x 2-1/2"	CWSE	Many OEM

ECM Evaporator Fan Motors

Features:

- 4 Bolts on Shaft End on 2.86" B.C.D.
- Lyall Plug Included
- Up to 65% Efficiency
- Replaces Heatcraft, Bohn, Larkin, Chandler & Climate Control ECM Evaporator Motors



All Models

42 Frame



Stock #	Encl.	HP	Volts	Amps.	RPM	Shaft	Rotation	Replaces
9215L	T.E.	1/15, 1/20, 1/25	115	1.20	1625	5/16" x 2.90"	CWSE	22617801, 22618001 25307801, 25308001
9215H	T.E.	1/15, 1/20, 1/25	230	0.70	1625	5/16" x 2.90"	CWSE	22617701, 22617901 25307701, 25307901

Features:

- Shaded Pole Design
- Sleeve Bearings
- Replacements for Reversomatic & Intercity



SS630



SS260 - SS262- SS264



SS266



SS2603 - SS2604



SS2605



SS2609 - SS2612

OEM Replacements

OMNIDRIVE®

Stock #	Encl.	HP	Volts	Amps.	RPM	Shaft	Rotation	Replaces
SS630	OPEN	---	120	0.75	3000	7/32" x 1-13/16"	CCWSE	R630
SS260	T.E.	1/90	115	0.60	1500	5/16" x 1.09"	CCWSE	R260
SS262	T.E.	1/40	115	1.10	1550	5/16" x 1-1/2"	CCWSE	R262
SS264	T.E.	1/75	120	0.70	1550	5/16" x 2.06"	CCWSE	R264
SS266	T.E.	1/20	120	1.45	1550	5/16" x 1.40"	CCWSE	R266
SS2603	OPEN	1/35	115	1.15	1550	1/2" x 2.10"	CCWSE	R2603
SS2604	OPEN	1/10	120	2.65	1550	1/2" x 2.05"	CCWSE	R2604
SS2605	OPEN	1/12	115	3.00	1050	1/2" x 1.98"	CCWSE	R2605
SS2609	T.E.	1/30	115	1.21	1550	1/2" x 2.35"	CCWSE	R2609
SS2612	T.E.	1/30	115	1.21	1550	1/2" x 2.35"	CWSE	R2612

Fan Coil Motors

Features:

- P.S.C. Design
- Capacitor Included
- Sleeve Bearings
- Replacements for Temspec, Unilux, Climetec & Snyder-General



SS799 - SS2799



799

42 & 48 Frame

OMNIDRIVE®

Stock #	Encl.	HP	Volts	Amps.	RPM	Shaft	Rotation	Replaces
SS799 *	OPEN	1/8	115	2.10	1000/5	1/2" x 5.00"	CWSE	DD-029
SS2799 *	OPEN	1/6	115	2.60	950/5	1/2" x 4.40"	CWSE	DD-030
799	OPEN	1/8	115	2.60	1000	1/2" x 5.00"	CWSE	DA3E200, DA3F100, DA3G142



Formerly A.O. Smith Electrical Products Company



ECM Fan Coil Replacement

Features:

- Energy Efficient ECM Technology
- ECM with Internal Control
- Up to 65% Efficiency vs. Low Efficiency Shaded Pole
- Rotors are Isolated from Shaft to Reduce Motor Vibration
- Saves an Average of 69% on Energy Usage
- Double Shaft
- Open Construction
- Resilient Base
- 54” Leads
- Runs Cooler
- Easy to Install
- Long Life Ball Bearings



42 Frame ECM

CS89



Formerly A.O. Smith Electrical Products Company

Stock #	Encl.	HP	Volts	Amps.	RPM	Shaft	Rotation
CS89 •	OPEN	1/10	115	1.56	1100/3	9.30" x 1/2" x 9.30"	CWLE

**Replaces many Shaded Pole & P.S.C. Motors
In Fan Coil, PTACS & Air Conditioners**

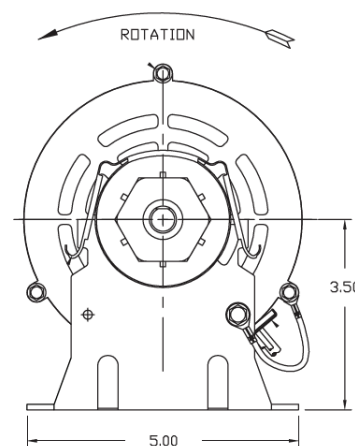
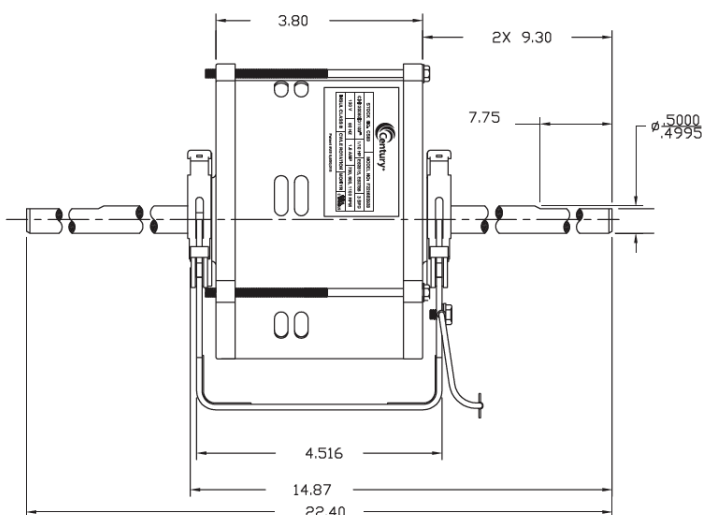

Features:

- Shaded Pole & P.S.C. Design
- Open & Totally Enclosed
- 60 Hz
- Sleeve Bearings
- Thermally Protected



SS6W115 - SS9W115



SS16W115 - SS16W230
SS34W115 - SS34W230



RMT0004 - RMT0005

New Product



SS1586 - SS1616 - SS1617



SS7004



SS1893 - SS1895

OMNIDRIVE®

Stock #	Watts	HP	Volts	Amps.	RPM	Shaft	Rotation
New SS6W115	6	---	115	0.41	1550	Hubless	CCWSE
New SS9W115	9	---	115	0.58	1550	Hubless	CCWSE
New SS16W115	16	---	115	0.89	1550	Hubless	CCWSE
New SS16W230	16	---	230	0.50	1550	Hubless	CCWSE
New SS34W115	34	---	115	1.60	1550	Hubless	CCWSE
New SS34W230	34	---	230	0.80	1550	Hubless	CCWSE
New RMT0004 ●	34	---	115	1.60	1550	Hubless	CCWSE
New RMT0005 ●	34	---	230	0.80	1550	Hubless	CCWSE
New SS1586 ●*	41	1/20	115	1.07	1550/2	1/2" x 3-29/32"	CWSE
New SS1616 ●*	---	1/8	115	2.16	1550/2	1/2" x 3-3/4"	CWSE
New SS1617 ●*	---	1/4 - 1/8	115	2.52 / 1.22	1090	1/2" x 3-1/2"	CWSE
New SS1893 ●*	50	1/15	115	0.82	1550/6	7-3/4" x 1/2" x 7-3/4"	CWSE
New SS1895 ●*	420	1/4	115	3.60	1550/6	8-7/16" x 1/2" x 8-7/16"	CWSE
New SS7004 ●*	40	1/15	115	0.93	1550/2	5/16" x 1-7/16"	CCWSE

Fan Coil Motors



42 Frame

Century®
Formerly A.O. Smith Electrical Products Company

OMNIDRIVE®

Stock #	Encl.	HP	Volts	Amps.	RPM	Shaft	Rotation
89	OPEN	1/10	115	3.20	1050/5	10-11/16" x 1/2" x 10-11/16"	DBL
New UE89P *	OPEN	1/10	115	2.50	1050/5	10-1/2" x 1/2" x 10-1/2"	DBL
93V1	OPEN	1/10	115	3.20	1050/5	10" x 3/8" x 10"	DBL
320	OPEN	1/15	208-230	1.30	1050/3	8-7/8" x 1/2" x 8-7/8"	DBL
362 *	OPEN	1/10	115	1.70	1075/4	10-11/16" x 1/2" x 10-11/16"	DBL
381 *	OPEN	1/10	208-230	0.81	1075/3	10-11/16" x 1/2" x 10-11/16"	DBL
953 *	OPEN	1/15	115	0.80	1100/3	10-1/2" x 1/2" x 10-1/2"	DBL
945A *	OPEN	1/8	115	1.20	1500/3	9" x 1/2" x 7-1/2"	DBL
955 *	OPEN	1/6	115	2.00	1500/3	10-1/2" x 1/2" x 10-1/2"	DBL
New UE955 *	OPEN	1/6	115	2.30	1500/3	10-1/2" x 1/2" x 10-1/2"	DBL
954 *	OPEN	1/30	115	0.60	1100/3	1/2" x 8-1/2"	CCWSE
9608 *	OPEN	1/20	115	0.60	1100/3	1/2" x 9-1/2"	REV.

(●) Ball Bearing (*) P.S.C. Design

New Product

Features:

- Shaded Pole & P.S.C. Design
- Capacitor Included
- Open Air-Over Design
- Wiring Harness w/Plug Supplied
- Long Life Self Aligning Sleeve & Sealed Ball Bearings

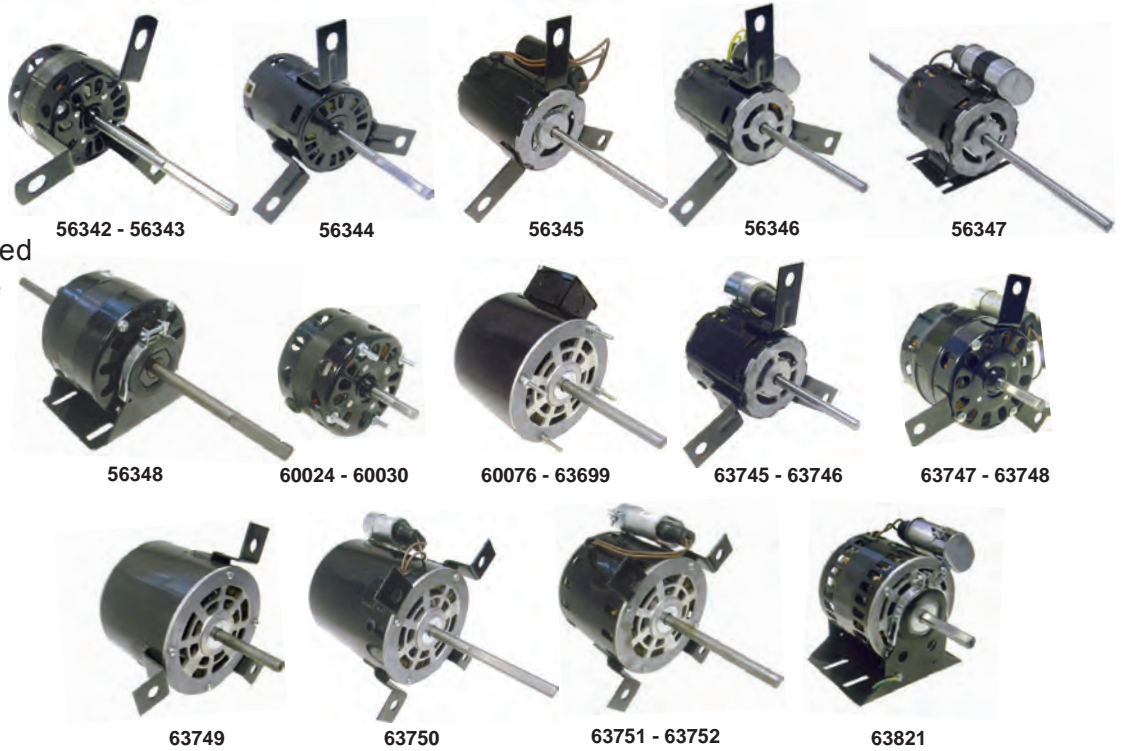

OEM Replacements

OMNIDRIVE

	Stock #	Diameter	HP	Volts	Amps.	RPM	Shaft	Rotation	Replaces
	56342	3.3"	1/70	115	1.00 / 0.50	1550/2	3/8" x 5-1/2"	CWSE	56342-0
	56343	3.3"	0.27	115	1.32	1550/2	3/8" x 5-3/4"	CWSE	56343-0, JA2M414
	56344 ●*	3.3"	0.08	115	1.60 / 1.00	1550/2	3/8" x 4.75"	CWSE	56344-0, JE2H047
	56345 *	3.3"	1/25	115	1.00	1050	3/8" x 4.75"	CWSE	56345-0
	56346 ●*	3.3"	0.27	115	3.20 / 1.90	1550/2	3/8" x 5.50"	CWSE	56346-0, JE2K007
	56347 ~*	3.3"	1/12	115	1.60	1050	6.10" x 3/8" x 6.10"	CCWLE	56347-0
	56348 ~	5.0"	1/10	115	3.90	1050	6-1/4" x 1/2" x 6-1/4"	CCWLE	56348-0
	60024	3.3"	1/30	115	1.40	1550	5/16" x 1-1/2"	CWSE	60024-0
	60030	3.3"	1/80	115	0.74	1400	1/4" x 1-3/4"	CWSE	60030-0
	60076 ●*	5.5"	1/6	115	3.40	1300/2	1/2" x 2.65"	CWSE	60076-0
	63699 ●*	5.5"	1/4	115	3.40	1725	1/2" x 4.77"	CWSE	63699-0
	63745 *	3.3"	1/30	115	0.50 / 0.40	1550/2	3/8" x 3.69"	CWSE	63745-0
	63746 ●*	3.3"	1/12	115	1.50 / 0.90	1550/2	3/8" x 3.40"	CWSE	63746-0, JE2H057
	63747 *	4.4"	1/7	115	2.50	1550/3	1/2" x 2.20"	CWSE	63747-0
	63748 *	4.4"	1/6	115	1.80	1550/3	1/2" x 2.60"	CWSE	63748-0
	63749 ●*	5.5"	1/4	115	2.80	1725	1/2" x 3.00"	CWSE	63749-0
	63750 ●*	5.5"	1/3	115	4.00	1550/3	1/2" x 5.55"	CWSE	63750-0
	63751 ●*	5.5"	1/2	120	5.00	1650/2	1/2" x 5.50"	CWSE	63751-0
	63752 ●*	5.5"	3/4	115	8.60 / 9.60	1625	1/2" x 5.33"	CWSE	63752-0
	63821 ●*	5.0"	1/4	115	2.70	1550	1/2" x 2.60"	CCWSE	63821-0

New Product



OEM Replacements

OMNIDRIVE®

Stock #	Encl.	HP	Volts	Amps.	RPM	Shaft	Rotation	Replaces
11811 *	OPEN	1/6	120	2.10	1630/2	3/8" x 1.90"	CCWSE	Venmar/ VanEE
12026 •*	OPEN	1/8	120	1.89	1630/3	2.93" x 3/8" x 2.93"	CWLE	Venmar/ VanEE
12027 *	OPEN	1/12	120	1.20	1625/3	3.50" x 3/8" x 3.56"	CWLE	Venmar/ VanEE
SS348 *	OPEN	1/15	115	1.30	1550/2	3/8" x 3.00"	CWSE	Venmar/ VanEE
SS438 *	OPEN	1/14	115	1.46	1625/2	5/16" x 1.88"	CCWSE	Venmar/ VanEE
SS462 *	OPEN	1/12	120	1.20	1625/3	3.50" x 3/8" x 3.56"	CWLE	Venmar/ VanEE
950-1020	OPEN	1/25	115	1.37	3000	5/16" x 2-1/4"	CCWSE	Tjernlund
950-1021 *	OPEN	1/7	115	1.50	3300	3/8" x 2.25"	CCWSE	Tjernlund
950-1022 •*	OPEN	1/5	115	2.80	1700	1/2" x 3.40"	CCWSE	Tjernlund
SS2224	OPEN	1/114	115	0.75	1500/2	3/8" x 2-3/4"	CWSE	Loren Cook
SS2497	OPEN	1/10	115	3.40	1100	1/2" x 1-5/8"	CWSE	Lomanco
SS2655 •*	OPEN	1/12	120	1.34	1550	3/8" x 2.82"	CCWLE	Nutech
SS3234	OPEN	1/16	115	2.20	1550/2	3/8" x 2-1/2"	CWSE	Loren Cook
SS4200	OPEN	1/23	115	1.50	1500	3/8" x 2-3/4"	CWSE	Loren Cook
SS5200 *	OPEN	1/16	115	1.50	1500	3/8" x 2-1/4"	CWSE	Loren Cook
SS6264	OPEN	1/11	115	4.60	1500/2	1/2" x 6-1/4"	CWSE	Loren Cook
SS7274 *	OPEN	1/4	115	3.90	1625/2	1/2" x 6-1/4"	CWSE	Loren Cook
SS8318 *	OPEN	1/8	115	2.60	1550/3	1/2" x 2-3/4"	CCWSE	Greenheck
SS9316	OPEN	---	115	3.40	1100	1/2" x 3-7/8"	CWSE	Broan
SS9317	OPEN	---	115	4.30	1100	1/2" x 3-7/8"	CWSE	Broan
30080058	OPEN	1/100	115	0.61	1050	5/16" x 1-7/8"	CCWSE	Broan
30080135 *	OPEN	1/10	120	1.80	1050	1/2" x 2-3/8"	CWSE	Broan

(•) Ball Bearing (*) P.S.C. Design



Features:

- All Angle Mount
- Continuous Duty, Air Over
- Class 'B' Insulation
- Shaded Pole
- Thermally Protected
- Single & Two Speed Models
- Sleeve Bearings



UB1



UB3



UB160



UB265



UB465



UFB500

3.3" Diameter

OMNIDRIVE®	Stock #	CFM	Volts	Amps.	RPM	Comments	Replaces
	UB1	200	115	1.20	3000	6' Cord & Plug	RB1
	UB3	100	120	0.80	3000	6' Cord & Plug	RB3
	UB160	160	115	1.10	1550	Leads - No Conduit Box	RB160
	UB265	265	115	1.40	1630	Conduit Box	RB265
	UB465	465	115	2.60	1550/2	2 Speed, Conduit Box, Heat Sink	RB465
	UFB500	140	120	1.10	2860	Conduit Box	RFB500

Inline Centrifugal Fans

Features:

- Installs in any Position
- High Pressure & Volume
- 8 Foot Cord & w/Plug Supplied
- Mounting Bracket Included
- Backwards Inclined Fan Blades
- Steel Housing, Baked Powder Coat Finish
- Permanently Sealed Ball Bearings
- Three Year Warranty



All Models

OMNIDRIVE®	Stock #	Duct Diameter	CFM	Watts	Volts	Amps.	Hz.	dBa
	VENT-100 ●	4 INCH	175	98	120	0.97	60	0.90
	VENT-150 ●	6 INCH	435	130	120	0.97	60	1.00
	VENT-200 ●	8 INCH	745	210	120	1.76	60	1.90
	VENT-250 ●	10 INCH	785	230	120	2.00	60	1.90
	VENT-315 ●	12 INCH	1075	295	120	2.50	60	2.60



RESCUE Select®

Features:

- **The ECM Aftermarket Motor that Replaces OEM Constant Torque Blower Motors**
- Electronically Controlled Brushless Permanent Magnet Motor
- Saves 25% of the Watts in A/C or Heating
- 75% Watt Reduction in Circulation Mode
- A Variety of Mounting Kits are Available
- Electronically Protected Motor
- Continuous Duty, Air Over
- 6000V Surge Protection
- No Capacitor Required
- Voltage 230V or 115V
- Up to 82% Efficiency
- Reversible Rotation
- Class 'B' Insulation
- 2 Year Warranty
- 40°C Ambient
- Ball Bearings

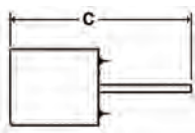

Replaces Over 900 OEM X13®† and SelecTech®† ECM Motors

Now Customized for You and Shipped Same Day from Stock !

48 Frame



Stock #	Encl.	HP Range	Volts	Amps.	RPM	"C" Dim.	Shaft	Rotation
EM-6630RS	OPEN	1/2 - 1/3	115	6.40	600/1200	11.75"	1/2" x 5.50"	REV.
EM-6640RS	OPEN	3/4	115	9.30	600/1200	12.25"	1/2" x 5.50"	REV.
EM-6650RS	OPEN	1	115	10.60	600/1200	12.75"	1/2" x 5.50"	REV.
EM-6631RS	OPEN	1/2 - 1/3	208 - 230	4.60 / 4.30	600/1200	11.75"	1/2" x 5.50"	REV.
EM-6641RS	OPEN	3/4	208 - 230	6.30 / 6.10	600/1200	11.25"	1/2" x 5.50"	REV.
EM-6651RS	OPEN	1	208 - 230	6.40 / 6.60	600/1200	12.75"	1/2" x 5.50"	REV.

† All marks shown within this document are properties of their respective owners.

MULTI-HP RATED MOTORS

Features:

- P.S.C. Design
- Energy Efficient
- Resilient Rings
- 40°C Ambient
- Reversible Rotation
- Open Construction
- Class 'B' Insulation
- Extended Thru Bolts
- Rheem Mounting Holes in Shell
- Sleeve and Ball Bearings



All Models

48 Frame - Four Speed

OMNIDRIVE®

Stock #	Encl.	HP	Volts	Amps.	RPM	Shaft	Capacitor
New SS3463 *	OPEN	1/2	115	7.00	1075/4	1/2" x 5.00"	10/370, 7.5/370
New SS3464 *	OPEN	1/2	208-230	3.90	1075/4	1/2" x 5.00"	5/370
New SS3466 *	OPEN	3/4	115	9.10	1075/4	1/2" x 5.00"	5/370
New SS3467 *	OPEN	3/4	208-230	3.90	1075/4	1/2" x 5.00"	5/370

Cross Reference

Century	Emerson	Genteq	Marathon	Fasco	Rotom
FDL6001A	5460	3463	X077	D2835	R43600
FD6000A	5461	3464	X073	D833	R43601
FDL6002A	5470	3466	X074	D2832	R43602
FD6001A	5471	3467	X075	D2833	R43603

Features:

- Resilient Rings Included
- Reversing Plug
- Extended Thru Bolts
- Thermally Protected
- 40°C Ambient Rating
- Long Life Self-Aligning Sleeve Bearings



EM-1390 - EM-1391



All OmniDrive Models



EM-8906 - EM-8907

42 Frame - Three Speed



Stock #	Encl.	HP	Volts	Amps.	RPM	Shaft	Rotation	Replaces
EM-1390	OPEN	1/4	115	2.80	1075/3	1/2" x 4.00"	REV.	D150
EM-1391	OPEN	1/4	208-230	1.50	1075/3	1/2" x 4.00"	REV.	D151

48 Frame - Three Speed



Stock #	Encl.	HP	Volts	Amps.	RPM	Shaft	Rotation	Replaces
SS3583	OPEN	1/4	115	4.20	1075/3	1/2" x 4-1/2"	REV.	DD-3583
SS3584	OPEN	1/4	208-230	2.00	1075/3	1/2" x 4-1/2"	REV.	DD-3584
SS1314	OPEN	1/3	115	6.00	1075/4	1/2" x 5-1/8"	CCWLE	DD-1314 F1314D
SS3585	OPEN	1/3	115	5.50	1075/3	1/2" x 4-1/2"	REV.	DD-3585
SS3586	OPEN	1/3	208-230	2.80	1075/3	1/2" x 4-1/2"	REV.	DD-3586
SS3587	OPEN	1/2	115	7.50	1075/3	1/2" x 4-1/2"	REV.	DD-3587
SS3588	OPEN	1/2	208-230	3.60	1075/3	1/2" x 4-1/2"	REV.	DD-3588
SS3589	OPEN	3/4	115	10.20	1075/3	1/2" x 4-1/2"	REV.	DD-3589
SS3590	OPEN	3/4	208-230	5.50	1075/3	1/2" x 4-1/2"	REV.	DD-3590
EM-8906 •	OPEN	1	115	12.30	1075/3	1/2" x 6-7/16"	REV.	R42812
EM-8907 •	OPEN	1	208-230	5.10	1075/3	1/2" x 6-7/16"	REV.	R42023

Features:

- Fits 9" & 10" Bolt Circle Diameter
- Reversing Plug
- Thermally Protected
- 40°C Ambient Rating
- Long Life Self-Aligning Sleeve Bearings



All Models

48 Frame - Four Speed



Stock #	Encl.	HP	Volts	Amps.	RPM	Shaft	Rotation	Replaces
SS752	OPEN	1/4	115	3.60	1075/4	1/2" x 6.00"	REV.	DD-034
SS753	OPEN	1/3	115	4.80	1075/4	1/2" x 6.00"	REV.	DD-035
SS754	OPEN	1/2	115	8.20	1075/4	1/2" x 6.00"	REV.	DD-036
SS973	OPEN	1/3	208-230	2.30	1075/4	1/2" x 6.00"	REV.	DD-045
SS974	OPEN	1/2	208-230	3.80	1075/4	1/2" x 6.00"	REV.	DD-046

(•) Ball Bearing



Ultimate Truck Stock Motor™

Features:

- High Efficiency P.S.C. Design
- Extended Mounting Studs
- Designed for Use With 370V Capacitors
- Class 'B' Insulation
- 36" Leads
- Includes Side Shell Holes For Rheem Units
- Continuous Duty, Air Over
- Reversible Rotation
- Automatic Reset Thermal Overload Protector
- 2.5" Diameter Hub Rings Included
- Sleeve and Ball Bearings



All Models

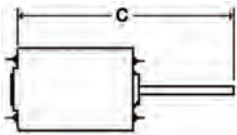

48 Frame - Four Speed



Stock #	Encl.	HP	Volts	Amps.	RPM	"C" Dim.	Shaft	Rotation
EM-5469 *	OPEN	1/3	208-230	2.40	825/4	6.74"	1/2" x 2.20"	REV.
EM-5460 *	OPEN	1/2	115	7.30	1075/4	9.80"	1/2" x 5.00"	REV.
EM-5461 *	OPEN	1/2	208-230	3.60	1075/4	9.80"	1/2" x 5.00"	REV.
EM-5470 ●*	OPEN	3/4	115	8.10	1075/4	11.60"	1/2" x 5.00"	REV.
EM-5471 ●*	OPEN	3/4	208-230	4.10	1075/4	11.60"	1/2" x 5.00"	REV.

Cross Reference

	Rotom	Genteq	Century	Marathon	Fasco
EM-5469	N/A	N/A	N/A	N/A	N/A
EM-5460	R6-R43600	3463	FDL6001A	X077	D2835
EM-5461	R6-R43601	3464	FD6000A	X073	D833
EM-5470	R6-R43602	3466	FDL6002A	X074	D2832
EM-5471	R6-R43603	3467	FD6001A	X075	D2833



RESCUE EcoTech®

Features:

- Electronically Controlled Brushless Permanent Magnet Motor
- Up to 82% Efficiency
- Saves 25% of the Watts in A/C or Heating
- 75% Watt Reduction in Circulation Mode
- Easy Voltage Change from 230V to 115V
- Electronically Protected Motor
- Continuous Duty, Air Over
- No Capacitor Required
- 6000V Surge Protection
- Reversible Rotation
- Class 'B' Insulation
- 36" Leads
- 40°C Ambient
- Ball Bearings



All Models

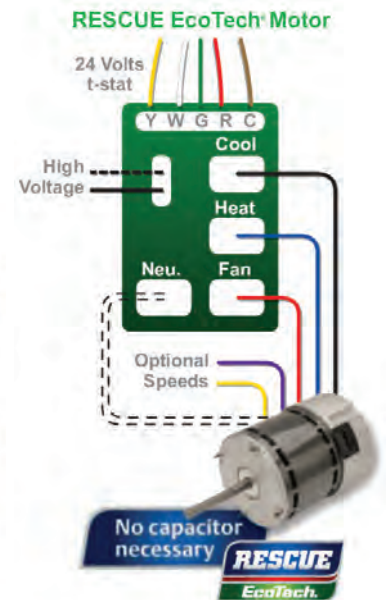

Actual connections may vary

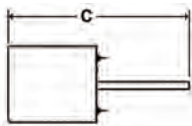

48 Frame - Five Speed



Formerly Emerson Motors

Stock #	Encl.	HP Range	Volts	Amps.	RPM	"C" Dim.	Shaft	Rotation
New EM-5522ET	• OPEN	1/3 - 1/5	115 / 230	4.02 / 2.70	1075/5	9.75"	1/2" x 4.50"	REV.
New EM-5532ET	• OPEN	1/2 - 1/4	115 / 230	6.20 / 3.90	1075/5	9.75"	1/2" x 4.50"	REV.
New EM-5542ET	• OPEN	3/4 - 1/3	115 / 230	8.50 / 5.20	1075/5	10.75"	1/2" x 4.50"	REV.
New EM-5552ET	• OPEN	1 - 1/2	115 / 230	11.50 / 6.90	1075/5	11.25"	1/2" x 4.50"	REV.

Cross Reference

	Rotom	Genteq	Mars	Century
EM-5522ET	N/A	6103E *	N/A	N/A
EM-5532ET	R6-R75531 R6-R755301	6105E *	06005	CSL1056 CS1056
EM-5542ET	N/A	6107E *	N/A	N/A
EM-5552ET	R6-R75551 R6-R755501	6110E *	06010	CSL1106 CS1106

(* 115 Volt Only)

- **Fits a Wide Variety of Applications** – The fully reversible motor comes in a range of horsepower sizes to fit your market and is dual voltage so you can provide an indoor blower solution to all your customers.
- **Quiet, Efficient Circulation Speed** – With a low 600 RPM circulation speed, your customers can cycle air continuously without the noise, draft or electricity cost of a PSC motor. Often using less energy than a 100 watt bulb. Up to 75% watts savings are typical.
- **Active Airflow Management** – The advanced motor control reacts to change in static pressure, helping to maintain airflow as vents are closed or the filter becomes dirty.
- **Very Energy Efficient** – The RESCUE EcoTech motor is up to 25% more electrically efficient at high speed compared to a standard blower motor. 75% watt reduction in circulation mode.

(•) Ball Bearing



60°C Ambient

Features:

- Single Phase P.S.C.
- Thermally Protected
- Reversible Rotation
- 36" Leads
- Continuous Duty, Air Over
- Extended Mounting Studs
- High Efficiency Design
- Ball Bearings



All Models

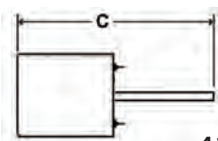

42 Frame



Stock #	Encl.	HP Range	Volts	Amps.	RPM	"C" Dim.	Shaft	Rotation
9722 ●*	T.E.	1/8 - 1/12	208-230	0.90	1075	7.50"	1/2" x 3.00"	REV.
9723 ●*	T.E.	1/4 - 1/6	208-230	2.00	1075	7.50"	1/2" x 3.00"	REV.
9724 ●*	T.E.	1/4 - 1/6	208-230	1.60	1625	7.50"	1/2" x 3.00"	REV.

Motor Mount Brackets & Capacitors

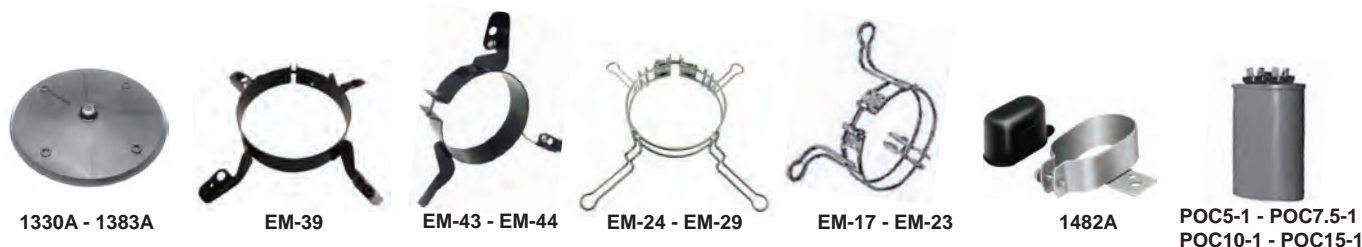

Accessories

Stock #	Description
1330A	Rain Shield for 1/2" Shaft
1383A	Rain Shield for 5/8" Shaft
New EM-43	5" (42 Frame) 9" & 10" B.C.D. 3 Lugs
New EM-44	5-5/8" (48 Frame) 9" & 10" B.C.D. 3 Lugs
New EM-39	5-5/8" (48 Frame) 9" & 10" B.C.D. 4 Lugs
New EM-17	Heavy Duty 5-5/8" (48 Frame) 10" B.C.D. 3 Lugs
New EM-23	Heavy Duty 5-5/8" (48 Frame) 11" B.C.D. 3 Lugs
New EM-24	Heavy Duty 5-5/8" (48 Frame) 15" B.C.D. 4 Lugs
New EM-29	Heavy Duty 5-5/8" (48 Frame) 16" B.C.D. 4 Lugs
1482A	Capacitor Mounting Bracket & Rubber Cover
POC5-1	5mfd / 370V. Oval Case
POC7.5-1	7.5mfd / 370V. Oval Case
POC10-1	10mfd / 370V. Oval Case
POC15-1	15mfd / 370V. Oval Case



Ultimate Truck Stock Motor™

Features:

- High Efficiency P.S.C. Design
- EZ-FIT® Mounting System to Cover 4.3", 4.4" or 4.6" Bolt Circle Mounts
- High 70°C (158°F) Ambient Design
- Automatic Reset Thermal Overload Protector
- Designed for Use with 370V Capacitors
- Special Treated Rotor For Corrosion Protection
- Totally Enclosed, Air Over (TEAO)
- Continuous Duty, Air Over
- Extended Mounting Studs
- Reversible Rotation
- 36" Leads
- Ball Bearings

70°C Ambient

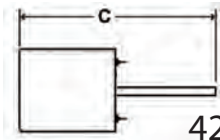

42 Frame



All Models



Stock #	Encl.	HP Range	Volts	Amps.	RPM	"C" Dim.	Shaft	Rotation
New EM-5440H •*	T.E.	1/8 - 1/12	208-230	0.80	1075	8.00"	1/2" x 3.00"	REV.
New EM-5441H •*	T.E.	1/4 - 1/6	208-230	1.50	1075	8.50"	1/2" x 3.00"	REV.
New EM-5442H •*	T.E.	1/4 - 1/6	208-230	1.60	1625	8.50"	1/2" x 3.00"	REV.

Cross Reference

	Rotom *	Genteq *	Century *	Fasco *
EM-5440H	M4-R2722	2S005, 2251	9722	G2243, G2248, G2249
EM-5441H	M4-R2723	2S003, 2250	9723	G2247, G2246, G2244, G2245
EM-5442H	M4-R2724	N/A	9724	N/A

(*) These motors are rated 60°C Ambient



EZ-FIT® Motor Mounting Bracket

Assembled out of the box to use as a clam shell replacement. Easily adapts to a 4.4" or 4.6" bolt circle for other applications



Clam Shell
4.3" Bolt Circle



3 Pc
4.4" Bolt Circle



3 Pc
4.6" Bolt Circle



60°C Ambient New Product

Features:

- Single Phase P.S.C.
- Totally Enclosed, Air Over
- Reversible Rotation
- Automatic Overload
- Ball Bearings

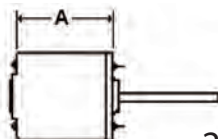

208-230V - 825 RPM

OMNIDRIVE®



Stock #	Encl.	HP	Volts	Amps.	RPM	"A" Dim.	Shaft	Rotation	Replaces
SS3403 •	T.E.A.O	1/6	208-230	1.10	825	4.11"	1/2" x 6.00"	REV.	CF-816, 3203
SS3404 •	T.E.A.O	1/4	208-230	1.50	825	4.61"	1/2" x 6.00"	REV.	CF-814, 3204
SS3405 •	T.E.A.O	1/3	208-230	1.80	825	5.11"	1/2" x 6.00"	REV.	CF-813, 3205
SS3746 •	T.E.A.O	1/2	208-230	2.70	825	5.61"	1/2" x 6.00"	REV.	CF-812, 3747HS



208-230V - 1075 RPM

Stock #	Encl.	HP	Volts	Amps.	RPM	"A" Dim.	Shaft	Rotation	Replaces
SS3727 •	T.E.A.O	1/6	208-230	1.10	1075	3.86"	1/2" x 6.00"	REV.	CF-3726, 3727
SS3728 •	T.E.A.O	1/4	208-230	2.00	1075	4.11"	1/2" x 6.00"	REV.	CF-3732, 3732
SS3729 •	T.E.A.O	1/3	208-230	2.50	1075	4.61"	1/2" x 6.00"	REV.	CF-3733, 3733
SS3730 •	T.E.A.O	1/2	208-230	3.40	1075	5.11"	1/2" x 6.00"	REV.	CF-3734, 3734
SS3731 •	T.E.A.O	3/4	208-230	5.30	1075	5.36"	1/2" x 6.00"	REV.	CF-3735, 3735

460V - 825 RPM

Stock #	Encl.	HP	Volts	Amps.	RPM	"A" Dim.	Shaft	Rotation	Replaces
EM-1880 •	T.E.A.O	1/4	460	1.00	825	5.10"	1/2" x 6.00"	REV.	---
EM-1881 •	T.E.A.O	1/3	460	1.00	825	5.60"	1/2" x 6.00"	REV.	3209

575V - 825 RPM

Stock #	Encl.	HP	Volts	Amps.	RPM	"A" Dim.	Shaft	Rotation	Replaces
SS3756 •	T.E.A.O	1/4	575	0.70	825	4.81"	1/2" x 5.00"	REV.	---
SS3757 •	T.E.A.O	1/3	575	1.10	825	5.31"	1/2" x 5.00"	REV.	---

575V - 1075 RPM

Stock #	Encl.	HP	Volts	Amps.	RPM	"A" Dim.	Shaft	Rotation	Replaces
5FE1036S •	T.E.A.O	1/3	575	0.80	1100	5.36"	1/2" x 6.50"	REV.	R42604
5FE1056S •	T.E.A.O	1/2	575	1.20	1100	5.61"	1/2" x 6.50"	REV.	R42606
5FE1076S •	T.E.A.O	3/4	575	1.90	1075	6.11"	1/2" x 6.50"	REV.	R42607

575V - 1625 RPM

Stock #	Encl.	HP	Volts	Amps.	RPM	"A" Dim.	Shaft	Rotation	Replaces
SS3762 •	T.E.A.O	1/2	575	1.00	1625	5.30"	1/2" x 6.50"	REV.	R42605, D2750

70°C Ambient

New Product

Features:

- Single Phase P.S.C.
- Totally Enclosed, Air Over
- Reversible Rotation
- Automatic Overload
- Ball Bearings

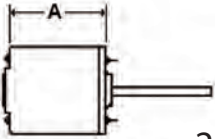

208-230V - 825 RPM

OMNIDRIVE®



Stock #	Encl.	HP	Volts	Amps.	RPM	"A" Dim.	Shaft	Rotation	Replaces
SS7403 ●	T.E.A.O	1/6	208-230	1.10	825	4.11"	1/2" x 6.00"	REV.	3203HS
SS7404 ●	T.E.A.O	1/4	208-230	1.40	825	4.68"	1/2" x 6.00"	REV.	3204HS
SS7405 ●	T.E.A.O	1/3	208-230	1.80	825	5.11"	1/2" x 6.00"	REV.	3205HS
SS7746 ●	T.E.A.O	1/2	208-230	2.50	825	5.61"	1/2" x 6.00"	REV.	3747HS



Formerly A.O. Smith Electrical Products Company

208-230V - 1075 RPM

Stock #	Encl.	HP	Volts	Amps.	RPM	"A" Dim.	Shaft	Rotation	Replaces
SS7727 ●	T.E.A.O	1/6	208-230	1.10	1075	3.86"	1/2" x 6.00"	REV.	3726HS
SS7728 ●	T.E.A.O	1/4	208-230	2.00	1075	4.11"	1/2" x 6.00"	REV.	3732HS
SS7729 ●	T.E.A.O	1/3	208-230	2.50	1075	4.61"	1/2" x 6.00"	REV.	3733HS
SS7730 ●	T.E.A.O	1/2	208-230	3.50	1075	5.11"	1/2" x 6.00"	REV.	3734HS
SS7731 ●	T.E.A.O	3/4	208-230	5.30	1075	5.36"	1/2" x 6.00"	REV.	3735HS

460V - 1075 RPM

Stock #	Encl.	HP	Volts	Amps.	RPM	"A" Dim.	Shaft	Rotation	Replaces
SS7736 ●	T.E.A.O	1/4	460	1.00	1075	4.74"	1/2" x 6.00"	REV.	3736HS
SS7737 ●	T.E.A.O	1/3	460	1.30	1075	5.24"	1/2" x 6.00"	REV.	3737HS
SS7738 ●	T.E.A.O	1/2	460	1.50	1075	5.61"	1/2" x 6.00"	REV.	3738HS

575V - 1075 RPM

Stock #	Encl.	HP	Volts	Amps.	RPM	"A" Dim.	Shaft	Rotation	Replaces
SS3758 ●	T.E.A.O	1/4	575	0.60	1075	4.31"	1/2" x 5.00"	REV.	---
SS3759 ●	T.E.A.O	1/3	575	0.70	1075	5.31"	1/2" x 5.00"	REV.	---
SS3760 ●	T.E.A.O	1/2	575	0.90	1075	5.56"	1/2" x 5.00"	REV.	---
SS3761 ●	T.E.A.O	3/4	575	1.60	1075	7.31"	1/2" x 5.00"	REV.	---

(●) Ball Bearing



Ultimate Truck Stock Motor™

Features:

- High Efficiency P.S.C. Design
- High 70°C (158°F) Ambient Design
- Automatic Reset Thermal Overload Protector
- Designed for Use With 370V Capacitors
- Special Treated Rotor For Corrosion Protection
- Includes Lead End Mounting Holes For Rheem or Trane Units
- Class 'F' Insulation
- Extended Mounting Studs
- Flat Lead End for Shaft Down Applications
- Reversible Rotation
- Continuous Duty, Air Over
- 48" Leads with Flag Terminals
- Ball Bearings

70°C Ambient



All Models

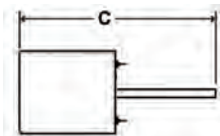

48 Frame - Two Speed



Stock #	HP Range	Volts	Amps.	RPM	"C" Dim.	Shaft	Rotation
EM-5464H ●*	1/3 - 1/6	208-230	1.90 - 1.00	825/2	10.30"	1/2" x 5.00"	REV.
EM-5462H ●*	1/3 - 1/6	208-230	2.60 - 1.80	1075/2	9.60"	1/2" x 5.00"	REV.
EM-5465H ●*	1/2 - 1/5	208-230	3.00 - 1.30	1075/2	10.30"	1/2" x 5.00"	REV.
EM-5482H ●*	3/4 - 1/4	208-230	4.00 - 1.40	1075/2	11.87"	1/2" x 5.00"	REV.
EM-5480H ●*	1/2 - 1/6	460	1.30 - 0.50	1075/2	11.10"	1/2" x 5.00"	REV.
EM-5481H ●*	3/4 - 1/4	460	2.20 - 0.70	1075/2	11.85"	1/2" x 5.00"	REV.

Cross Reference

	Rotom	Genteq	Century
EM-5464H	M2-R22601	3457HS, 3459HS	FE6001F
EM-5462H	M2-R22600	3456HS, 3458HS	FE6000F
EM-5465H	M2-R22602	3460HS	FE6002F
EM-5482H	M2-R22604	N/A	FE6003F
EM-5480H	N/A	N/A	N/A
EM-5481H	N/A	N/A	N/A



Features:

- Open Opposite Shaft-End & Totally Enclosed
- Single Phase P.S.C. & Three Phase
- Round Body & Rigid Base
- Reversible Rotation
- Auto Protection
- Ball Bearings



C770 - C081 - C771 - 181574



H564 - H977 - H567 - H961
H667 - H962 - H767 - H963



UEH962 - UEH686 - UEH699 - UEX526



H978



RMT0062



MA1074



181651

56 Frame - Single Phase

Stock #	Encl.	HP	Volts	Amps.	RPM	Shaft	Rotation	Replaces
C770 ●*	O.O.S.E.	1	200-230 / 460-1Ø	4.80 / 2.40	1075	5/8" x 6.00"	REV.	S1514
C081 ●*	O.O.S.E.	1	575-1Ø	2.20	1075	5/8" x 6.00"	REV.	S1516
C771 ●*	O.O.S.E.	1.5	200-230 / 460-1Ø	6.60 / 3.30	1075	5/8" x 6.00"	REV.	S1518
181574 ●*	O.O.S.E.	1.5	575-1Ø	2.70	1075	5/8" x 6.00"	REV.	S1520



56 Frame - Three Phase

Stock #	Encl.	HP	Volts	Amps.	RPM	Shaft	Rotation	Replaces
H564 ●	O.O.S.E.	1/2	200-230 / 460-3Ø	2.8-2.6 / 1.30	1140	5/8" x 6.00"	REV.	T2532
H977 ●	T.E.	1/2	575-3Ø	0.80	1140	5/8" x 3-3/8"	REV.	AICH977
H567 ●	O.O.S.E.	3/4	200-230 / 460-3Ø	2.8-3.0 / 1.50	1140	5/8" x 6.00"	REV.	T2534
H961 ●	O.O.S.E.	3/4	575-3Ø	1.25	1140	5/8" x 6.00"	REV.	T2535
H667 ●	O.O.S.E.	1	200-230 / 460-3Ø	5.3-5.2 / 2.60	1140	5/8" x 6.00"	REV.	T2538
H671 ●	O.O.S.E.	1	575-3Ø	2.00	1140	5/8" x 6.00"	REV.	T2540
New UEH686 ●	O.O.S.E.	1	208-230 / 460-3Ø	5.0 / 2.5	850	5/8" x 6.00"	REV.	T2537
H686 ●	O.O.S.E.	1	200-230 / 460-3Ø	4.4-4.0 / 2.00	850	5/8" x 5.00"	REV.	T2537
New UEH962 ●	O.O.S.E.	1	575-3Ø	2.10	850	5/8" x 6.00"	REV.	T2539
H962 ●	O.O.S.E.	1	575-3Ø	1.60	850	5/8" x 3-1/4"	REV.	T2539
H767 ●	O.O.S.E.	1.5	200-230 / 460-3Ø	5.8-6.0 / 3.00	1140	5/8" x 6.00"	REV.	T2542
H963 ●	O.O.S.E.	1.5	575-3Ø	2.30	1140	5/8" x 6.00"	REV.	T2543
New UEH699 ●	O.O.S.E.	2	208-230 / 460-3Ø	7.8 / 3.90	1140	5/8" x 6.00"	REV.	T2544
H978 ●	O.O.S.E.	SPL	208-230 / 460/575-3Ø	5.5 / 3.4 / 2.80	1140	5/8" x 3-1/2"	REV.	HD52AK652
RMT0062 ●	O.O.S.E.	1.5	575-3Ø	2.50	860	5/8" x 2-1/2"	REV.	RMT0062
MA1074 ●	T.E.	2	575-3Ø	3.10	1140	5/8" x 3.00"	REV.	MA1074
New UEX526 ●	O.O.S.E.	2	575-3Ø	2.80	1140	5/8" x 6.00"	REV.	T2536, X526
181651 ●	T.E.	2	575-3Ø	2.70	1140	5/8" x 2-1/2"	REV.	---

(●) Ball Bearing (*) P.S.C. Design

70°C Ambient

New Product

Features:

- Open Opposite Shaft-End
- Inverter Duty
- Class 'F' Insulation
- Automatic Overload
- Energy Efficient
- Reversible Rotation
- Ball Bearings
- Removable Bolt-on Base

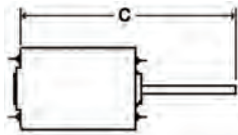

56 Frame - Three Phase - 208-230/460V



Stock #	Encl.	HP	Volts	Amps.	RPM	"C" Dim.	Shaft	Rotation
New H1055A •	O.O.S.E.	1/2	208-230/460	2.8-2.6 / 1.3	1140	16.09"	5/8" x 6.00"	REV.
New H1056A •	O.O.S.E.	3/4	208-230/460	2.8-3.0 / 1.5	1140	16.20"	5/8" x 6.00"	REV.
H1050A •	O.O.S.E.	1	208-230/460	4.0-4.4 / 2.2	1140	16.30"	5/8" x 6.00"	REV.
H1051A •	O.O.S.E.	1-1/2	208-230/460	5.8-5.8 / 2.9	1140	17.32"	5/8" x 6.00"	REV.
H1052A •	O.O.S.E.	2	208-230/460	7.0-7.4 / 3.7	1140	18.32"	5/8" x 6.00"	REV.
H1053A •	O.O.S.E.	1	208-230/460	5.0-5.2 / 2.6	850	18.32"	5/8" x 6.00"	REV.
H1054A •	O.O.S.E.	1-1/2	208-230/460	5.0-5.2 / 2.6	850	18.77"	5/8" x 6.00"	REV.

56 Frame - Three Phase - 575V

Stock #	Encl.	HP	Volts	Amps.	RPM	"C" Dim.	Shaft	Rotation
New 5H1050A •	O.O.S.E.	1	575	2.00	1140	16.30"	5/8" x 6.00"	REV.
New 5H1051A •	O.O.S.E.	1-1/2	575	2.40	1140	17.30"	5/8" x 6.00"	REV.
New 5H1052A •	O.O.S.E.	2	575	3.00	1140	18.30"	5/8" x 6.00"	REV.
New 5H1053A •	O.O.S.E.	1	575	1.80	850	18.30"	5/8" x 6.00"	REV.
New 5H1054A •	O.O.S.E.	1-1/2	575	3.00	850	18.78"	5/8" x 6.00"	REV.



Blanchard-Ness

Stock #	Encl.	HP	Volts	Amps.	RPM	Shaft	Rotation	Replaces
SS605	SKEL	---	120	1.00	2800	3/16" x 1-3/4"	CCWSE	AIC605
572A	OPEN	1/20	115	1.90	1550	5/16" x 3.00"	CWSE	D1124
573A	OPEN	1/15	208-230	1.30	1550	5/16" x 3.00"	CWSE	D1126
SS358	OPEN	1/20	115	2.00	1550	5/16" x 3.00"	CWSE	AIC1052
SS359	OPEN	1/20	208-230	1.10	1430	5/16" x 3.00"	CWSE	AIC1053
SS302	OPEN	1/100	240	0.30	1400	1/4" x 1.50"	CCWSE	E1004
SS326	OPEN	1/85	115	0.50	1550	1/4" x 1.45"	CCWSE	79101, E1001 E1002, E1003
New EM-9662 •*	OPEN	1/20	115	0.85	1550	5/16" x 3.00"	REV.	MA1009
New EM-9656 •*	OPEN	1/15	208-230	0.48	1550	5/16" x 3.00"	REV.	MA1010
New UEH977	O.O.S.E.	1/2	575	0.85	1140	5/8" x 3.30"	REV.	AICH977, T2533, T2529
SS3729 •*	T.E.	1/3	208-230	2.50	1075	1/2" x 6.00"	REV.	E1022, E1025
SS3730 •*	T.E.	1/2	208-230	3.40	1075	1/2" x 6.00"	REV.	E1064
H564 •	O.O.S.E.	1/2	200-230/460	2.8-2.6 / 1.30	1140	5/8" x 6.00"	REV.	E1020, E1066
H977 •	T.E.	1/2	575-3Ø	0.80	1140	5/8" x 3-3/8"	REV.	AICH977
H686	O.O.S.E.	1	200-230/460-3Ø	4.4-4.0 / 2.00	850	5/8" x 5.00"	REV.	T2537
New UEH686 •	O.O.S.E.	1	208-230/460-3Ø	5.0 / 2.50	850	5/8" x 5.00"	REV.	X507
H962 •	O.O.S.E.	1	575-3Ø	1.60	850	5/8" x 3-1/4"	REV.	X527
New UEH962 •	O.O.S.E.	1	575-3Ø	2.10	850	5/8" x 6.00"	REV.	X527
New UEH699 •	O.O.S.E.	2	208-230/460-3Ø	7.8 / 3.90	1140	5/8" x 6.00"	REV.	X509
New UEX526 •	O.O.S.E.	2	575-3Ø	2.80	1140	5/8" x 6.00"	REV.	X526



EM-9662 - EM-9656

H977 - 181651 - H698

MA1074

Cancoil Thermal

Stock #	Encl.	HP	Volts	Amps.	RPM	Shaft	Rotation	Replaces
New EM-9662 •*	OPEN	1/20	115	0.85	1550	5/16" x 3.00"	REV.	MA1009
New EM-9656 •*	OPEN	1/15	208-230	0.48	1550	5/16" x 3.00"	REV.	MA1010
H977 •	T.E.	1/2	575-3Ø	0.80	1140	5/8" x 3-3/8"	REV.	AICH977
181651 •	T.E.	2	575-3Ø	2.70	1140	5/8" x 2-1/2"	REV.	MA1003
MA1074 •	T.E.	2	575-3Ø	3.10	1140	5/8" x 3.00"	REV.	CAN2575
H698 •	T.E.	2	208-230/460	6.8-6.2 / 3.10	1140	5/8" x 6.00"	REV.	MA1075

New Product



Carrier

5OCA3056

OCA1056 - SS1506

5BD1106

H953V1

H955L

UEH955 - UEH953

181574

H978

H979L - H980L

HD60FE575

Stock #	Encl.	HP	Volts	Amps.	RPM	Shaft	Rotation	Replaces
New SS1506 •*	SEMI-ENCL	1/2	575	1.80	1075	1/2" x 1-9/16"	CCWLE	CCFM12575, HC43VE575
OCA1056 •*	SEMI-ENCL	1/2	200-230	4.60 / 2.30	1075	1/2" x 1-9/16"	REV.	3288, HC43VE200B
5OCA3056 •	SEMI-ENCL	1/2	575-3Ø	1.00	1140	1/2" x 2-1/2"	REV.	HD44ML461, P48J6A2
5BD1106 •*	OPEN	1	575	2.40	1075/2	1/2" x 5.00"	REV.	F1575DD, 50HJ900575
H953V1 •	OPEN	2	575-3Ø	2.40	1800	7/8" x 2.30"	REV.	F21853, HD52GA875
New UEH953 •	OPEN	2	575-3Ø	2.70	1725	7/8" x 2-1/4"	REV.	F21853, HD52GA875
H955L •	OPEN	3	575-3Ø	3.60	1800	7/8" x 2.30"	REV.	F31853, HD58DL575
New UEH955 •	OPEN	3	575-3Ø	3.40	1800	7/8" x 2.30"	REV.	F31853, HD58DL575
181574 •	O.O.S.E.	1.5	575	2.70	1075	5/8" x 6.00"	REV.	CCFM1575, HC51TE575
H978 •	O.O.S.E.	SPL	208-230/460/575-3Ø	5.5/3.4/2.8	1140	5/8" x 3-5/8"	REV.	HD52AK652
H979L •	OPEN	5	208-230/460-3Ø	15.00 / 7.40	1725	7/8" x 2-5/16"	REV.	HD60FK652
H980L •	OPEN	3	208-230/460-3Ø	10.60 / 4.80	1725	7/8" x 2-5/16"	REV.	HD60FK651
HD60FE575 •	OPEN	5	575-3Ø	5.60	1725	7/8" x 3-1/4"	REV.	HD60FE575



254 - 256

260

174A

OCP0251 - OCP0250

OCP1024

EM-1265 - EM-1275

Copeland

Stock #	Encl.	HP	Volts	Amps.	RPM	Shaft	Rotation	Replaces
254	OPEN	35W	115	1.40	1500	Hubless	CWLE	R3511, 050-0227-01
256	O.O.S.E	35W	230	0.70	1500	Hubless	CWLE	R3512, 050-0227-02
260	OPEN	50W	230	0.85	1500	3/8" x 1-1/2"	CWLE	R5012, 050-0017-01
174A *	OPEN	1/6	208-230	1.00	1625	1/2" x 2-1/2"	REV.	R3051
OCP0251 *	OPEN	1/6	230	1.50	1625	1/2" x 2-1/2"	CCWSE	050-0251-00
OCP0250 *	OPEN	1/4	230	1.50	1625	1/2" x 2-1/2"	CWLE	050-0250-00
OCP1024 •*	OPEN	1/4	208-230	1.50	1625	1/2" x 3.00"	CWLE	R3047, 050-0107-01
New EM-1265 *	OPEN	1/6	460	0.55	1550	1/2" x 3-1/16"	CWLE	050-0265-01
New EM-1275 *	OPEN	1/4	575	0.70	1625	1/2" x 3.00"	CWLE	050-0250-02 050-0266-02



SS9428

Dunham Bush

Stock #	Encl.	HP	Volts	Amps.	RPM	Shaft	Rotation	Replaces
SS9428	OPEN	1	575	1.70	1100	1/2" x 2-3/4"	REV.	HM3T007, HM3T010

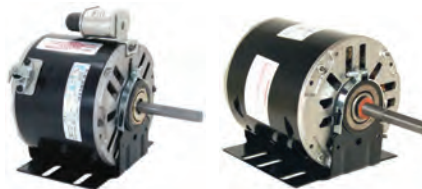

160A

OHR1106

Hill

Stock #	Encl.	HP	Volts	Amps.	RPM	Shaft	Rotation	Replaces
160A *	OPEN	1/3	208-230	3.00	1625	1/2" x 4.00"	REV.	R3001, PP3955B
OHR1106 •*	SEMI-ENCL	1	208-230	7.10 / 6.40	1075	1/2" x 3-3/4"	REV.	R3067, PP19162G



SS605

572A - 573A

EM-9662 - EM-9656

SS9721

SS3729 - SS3730

EM-4941

Heatcraft (Bohn/Larkin)

Stock #	Encl.	HP	Volts	Amps.	RPM	Shaft	Rotation	Replaces
SS605	SKEL	---	120	1.00	2800	3/16" x 1-3/4"	CCWSE	AIC605
572A	OPEN	1/20	115	1.90	1550	5/16" x 3.00"	CWSE	D1124
EM-9662 •*	OPEN	1/20	115	0.85	1550	5/16" x 3.00"	REV.	5001L, 5008S, 5004L 5034L, 5034LS, 5008SS
573A	OPEN	1/15	208-230	1.30	1550	5/16" x 3.00"	CWSE	D1126
EM-9656 •*	OPEN	1/15	208-230	0.48	1550	5/16" x 3.00"	REV.	7190-0442, 25309101 5008T, 5034M, 5034MS
SS9721 •*	OPEN	1/12	115/208-230	1.10/0.60	1550	5/16" x 3.15"	REV.	R90721, 253-9101
SS3729 •	T.E.	1/3	208-230	2.50	1075	1/2" x 6.00"	REV.	CF-3733
SS3730 •	T.E.	1/2	208-230	3.40	1075	1/2" x 6.00"	REV.	CF-3734
EM-4941 •*	T.E.	1/2	208-230/460	2.80/1.50	1100	1/2" x 4-1/2"	REV.	---



New Product

Hussmann

Stock #	Encl.	HP	Volts	Amps.	RPM	Shaft	Rotation	Replaces
OHS1004 *	OPEN	1/8	230	1.00	1550	1/2" x 2.00"	CWLE	3011
174A *	OPEN	1/6	208-230	1.00	1625	1/2" x 2-1/2"	REV.	3057
OHS1016 *	OPEN	1/5	230	1.60	1075	1/2" x 3.00"	CWLE	3009
OHS10206 ●*	OPEN	1/5	208-230	1.30	1075	1/2" x 3.00"	CWLE	3008/3012
OHS9983 ●*	OPEN	1/2	208-230	2.70	1725	1/2" x 3-1/2"	CWLE	R3051, 259983
New F062P ●	OPEN	1/20	600	0.42	1550	1/2" x 2-1/2"	CWSE	206578, HHC FM DA2F062, DA2F091
SS34201 ●*	OPEN	1/5	575	0.50	1075	1/2" x 3.30"	CCWSE	204201, R34201
New J055U ●*	T.E.	1/6	575	0.80	1650	1/2" x 3.20"	REV.	77238, 1042140 R30575, FM001
H667 ●	O.O.S.E.	1	200-230/460-3Ø	5.3-5.2/2.6	1140	5/8" x 6.00"	REV.	T2540
H671 ●	O.O.S.E.	1	575-3Ø	2.00	1140	5/8" x 6.00"	REV.	T2538



Keeprite

Stock #	Encl.	HP	Volts	Amps.	RPM	Shaft	Rotation	Replaces
SS370 ●*	OPEN	1/20	115	0.80	1550	5/16" x 2.80"	CCWSE	R370
SS371 ●*	OPEN	1/20	230	0.30	1550	5/16" x 2.80"	CCWSE	R371
SS2269	OPEN	1/15	115	2.70	1050	1/2" x 2.75"	CWSE	160269, R2269
SS2657	OPEN	1/15	230	1.20	1550	3/8" x 2.44"	CCWSE	81335, R2657
SS2658	OPEN	1/15	115	2.30	1550	3/8" x 2.44"	CCWSE	81356, R2658
FE1026 ●*	T.E.A.O.	1/4	208-230	1.80	1075/2	1/2" x 6.00"	REV.	AICF171672
New G004U ●	T.E.	1/4	575-3Ø	0.46	1100	5/8" x 2.93"	REV.	171065, R31065
5BD1076 ●*	OPEN	3/4	575-1Ø	2.30	1075/2	1/2" x 5.00"	REV.	F34575DD, HQ1095096
176826 ●	OPEN	1.25	208-230-3Ø	4.70-5.00	1140	5/8" x 3-1/4"	REV.	1043297-001, T1826
173946 ●	OPEN	1.25	575-3Ø	2.00	1140	5/8" x 3-1/4"	REV.	1043299-01, T1946
187289 ●	OPEN	1 SPL	575-3Ø	2.30	850	5/8" x 3-1/4"	REV.	1062968-001

New Product



Krack

9627 - 9628

EM-9662 - EM-9656

OKR1096

OKR1503

Stock #	Encl.	HP	Volts	Amps.	RPM	Shaft	Rotation	Replaces
9627	T.E.	1/25	115	1.30	1550	5/16" x 1-3/4"	CWSE	11528, JAZP216
9628	T.E.	1/20	200-230	0.90	1550	5/16" x 1-1/2"	CWSE	11529, JA2P217 JA2S149
EM-9662 ●*	OPEN	1/20	115	0.85	1550	5/16" x 3.00"	REV.	9633, E206447
EM-9656 ●*	OPEN	1/15	208-230	0.48	1550	5/16" x 3.00"	REV.	9634, E206448
OKR1096 ●	T.E.A.O.	1/2	208-230/460-3Ø	2.0-1.9/0.95	1140	5/8" x 2.00"	REV.	150372, 11096
OKR1503 ●	O.O.S.E.	1	200-230/460-3Ø	4.4-4.0/2.00	850	5/8" x 3-1/4"	REV.	151437, 11503



EM-1268

SS1314

9405A

9406A

LX9730 - 5BD1106

H671

H953V1

UEH953

Lennox

Stock #	Encl.	HP	Volts	Amps.	RPM	Shaft	Rotation	Replaces
EM-1268 *	OPEN	1/5	115	3.50	1075/4	1/2" x 3.50"	REV.	P-8-9662
SS1314 *	OPEN	1/3	115	6.00	1075/4	1/2" x 5-1/8"	CCWLE	DD-1314, F1314D
9405A ●*	OPEN	3/4	115	9.70	1075/5	1/2" x 3-1/8"	CCWLE	45H3301, 28F01
9406A ●*	OPEN	3/4	208-230	6.60	1075/3	6-1/2" x 5/8" x 5-1/4"	CCWLE	31C8201
LX9730 *	OPEN	3/4	460	2.30	1075/3	1/2" x 2.50"	CWSE	43G5201
5BD1106 ●*	OPEN	1	575	2.40	1075/2	1/2" x 5.00"	REV.	F34575DD, 88C7601
H671 ●	O.O.S.E.	1	575-3Ø	2.00	1140	5/8" x 6.00"	REV.	98G6501
H953V1 ●	OPEN	2	575-3Ø	2.40	1800	7/8" x 2.30"	REV.	32657/F21853
UEH953 ●	OPEN	2	575-3Ø	2.70	1725	7/8" x 2-1/4"	REV.	32657/F21853

(●) Ball Bearing (*) P.S.C. Design



C663



SS2531 - SS2535

Liebert

Stock #	Encl.	HP	Volts	Amps.	RPM	Shaft	Rotation	Replaces
C663	O.O.S.E.	3/4	208-230/460	4.80-4.20/2.10	1100	5/8" x 4.00"	CCWLE	B-0950
SS2531	O.O.S.E.	1	208-230/460	4.20/2.10	1140	5/8" x 6.00"	REV.	R2531
SS2535	O.O.S.E.	1	575	1.50	1140	5/8" x 3.20"	REV.	R2535



EM-9662 - EM-9656



SS368 - SS369



RMT0004 - RMT0005



RMT0062



MA1074

Ref Plus

Stock #	Encl.	HP	Volts	Amps.	RPM	Shaft	Rotation	Replaces
EM-9662 •*	OPEN	1/20	115	0.85	1550	5/16" x 3.00"	REV.	MA1009
EM-9656 •*	OPEN	1/15	208-230	0.48	1550	5/16" x 3.00"	REV.	MA1010
SS368	OPEN	1/20	115	1.80	1550	5/16" x 2-3/4"	CCWSE	RMT-0011
SS369	OPEN	1/20	208-230	0.90	1550	5/16" x 2-3/4"	CCWSE	RMT-0012
RMT0004 •	T.E.	34W	115	1.60	1550	Hubless	CCWSE	NU-34-45-2/1543
RMT0005 •	T.E.	34W	230	0.80	1550	Hubless	CCWSE	NU-34-45-4/1542
RMT0062 •	O.O.S.E.	1.5	575-3Ø	2.50	860	5/8" x 2-1/2"	REV.	43846, 43424
MA1074 •	T.E.	2	575-3Ø	3.10	1140	5/8" x 3.00"	REV.	RMT-0064



276



981



OTC6001 - OTC6004



EM-1779P - EM-1775P



9487



OTC1862 - OTC1864

Tecumseh

Stock #	Encl.	HP	Volts	Amps.	RPM	Shaft	Rotation	Replaces
276	OPEN	50W	230	0.85	1500	5/16" x 2-1/2"	CCWLE	810M050A62, TFM502
981	OPEN	1/15	460	0.60	1550	5/16" x 2-1/2"	CCWLE	810G037A47, 810G050A49
OTC6001	OPEN	1/15	230	1.30	1550	5/16" x 2-3/4"	CCWLE	810S050A99
EM-1779P *	OPEN	1/15	230	0.62	1625	5/16" x 3.00"	CCWSE	TFM502, 810E050A85 F48HXDEJ1779
9487	OPEN	1/12	230	1.30	1500	5/16" x 2-1/8"	CWLE	TFM262
OTC6004	OPEN	1/20	230	1.10	1550	5/16" x 2-1/2"	CCWLE	810S037B01, R2372
EM-1775P *	OPEN	1/20	230	0.50	1500	5/16" x 3.00"	CCWSE	F48DEF1775, TFM372 810E037A84
OTC1862 •*	OPEN	1/4	230	1.90	1625	1/2" x 2-3/4"	CWLE	TFM1862
OTC1864 •*	OPEN	1/4	460	0.95	1625	1/2" x 2-3/4"	CWLE	TFM1864



New Product

Trane

Stock #	Encl.	HP	Volts	Amps.	RPM	Shaft	Rotation	Replaces
954 *	OPEN	1/30	115	0.60	1100/3	1/2" x 8-1/2"	CWLE	MOT-1878, MOT-1875
9608 *	OPEN	1/20	115	0.60	1100/3	1/2" x 9-7/8"	REV.	MOT-1875, X70500149-02
955 *	OPEN	1/6	115	2.00	1500/3	10-1/2" x 1/2" x 10-1/2"	CWLE	MOT-1979, MOT-482
New UE955 *	OPEN	1/6	115	2.30	1500/3	10-1/2" x 1/2" x 10-1/2"	DBL	MOT-1979, MOT-482
680A *	OPEN	1/8	115	1.50	775/3	11-1/2" x 1/2" x 11-1/2"	CCWLE	MOT-711
5FE1056S ●*	T.E.A.O.	1/2	575	1.20	1100	1/2" x 6-1/2"	REV.	D2752
5FE1054S ●*	T.E.A.O.	1/2	575	1.40	1625	1/2" x 6-1/2"	REV.	D2750
5FE1076S ●*	T.E.A.O.	3/4	575	1.90	1075	1/2" x 6-1/2"	REV.	D2753, MOT-2607
5BD1076 ●*	OPEN	3/4	575	2.30	1075/2	1/2" x 5.00"	REV.	F34575DD, 21A309661P01
5BD1106 ●*	OPEN	1	575	2.40	1075/2	1/2" x 5.00"	REV.	F1575DD, X70671181-017 X70671479-001
H955L ●	OPEN	3	575-3Ø	3.60	1800	7/8" x 2.30"	REV.	F31853, MOT-6769 MOT-9800
New UEH955 ●	OPEN	3	575-3Ø	3.40	1800	7/8" x 2.30"	REV.	F31853, MOT-6769 MOT-9800
New SS9193 ●*	OPEN	1	575	2.20	1075	5/8" x 5-31/32"	REV.	X70671655-01, MOT09193



York

Stock #	Encl.	HP	Volts	Amps.	RPM	Shaft	Rotation	Replaces
SS7738 ●*	T.E.A.O.	1/2	460	1.50	1075	1/2" x 6.00"	REV.	YCM124SD, 024-24100-002
OYK1056V1 *	T.E.A.O.	1/2	208-230	2.50	1090	1/2" x 4.00"	CWLE	024-24110-701, 713
5BD1076 ●*	OPEN	3/4	575	2.30	1075/2	1/2" x 5.00"	REV.	F34575DD, 024-31946-003
EM-2553 *	OPEN	1	460	3.30	1100/3	1/2" x 4.00"	REV.	YEFM1460, 024-21671-000 024-21673-000
H953V1 ●	OPEN	2	575-3Ø	2.40	1800	7/8" x 2.30"	REV.	F21853, 024-19623-007
New UEH953 ●	OPEN	2	575-3Ø	2.70	1725	7/8" x 2-1/4"	REV.	F21853, 024-19623-007
H955L ●	OPEN	3	575-3Ø	3.60	1800	7/8" x 2.30"	REV.	F31853, 024-19623-009
New UEH955 ●	OPEN	3	575-3Ø	3.40	1800	7/8" x 2.30"	REV.	F31853, 024-19623-009

(●) Ball Bearing (*) P.S.C. Design



New Product

Features:

- Open Drip-Proof
- Class 'B' Insulation
- Reversible Rotation
- 60 Hz.
- Resilient Base
- Thermally Protected
- 1/2" to 5/8" Sleeve & Key Included
- Self-Aligning Sleeve & Sealed Ball Bearings



All US Motors Models

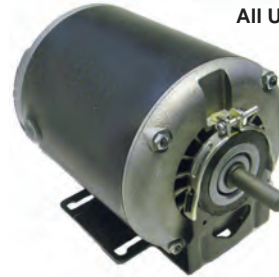

All OmniDrive Models



All Century Models

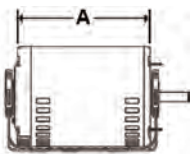

48 Frame - Single Speed

OMNIDRIVE

Century
Formerly A.O. Smith Electrical Products Company

Stock #	Encl.	HP	Volts	Amps.	RPM	"A" Dim.	Shaft	Rotation
SS933	OPEN	1/4	115	4.80	1725	6.81"	1/2" x 1.50"	REV.
SS934	OPEN	1/3	115	6.60	1725	6.81"	1/2" x 1.50"	REV.
SS935	OPEN	1/2	115	8.30	1725	7.76"	1/2" x 1.50"	REV.
SS934B ●	OPEN	1/3	115	6.60	1725	6.81"	1/2" x 1.50"	REV.
SS935B ●	OPEN	1/2	115	7.60	1725	6.81"	1/2" x 1.50"	REV.
New SS933D ●	OPEN	1/4	115/208-230	4.60/2.20-2.10	1725	6.75"	1/2" x 1.88"	REV.
New SS934D ●	OPEN	1/3	115/208-230	6.60/3.40-3.10	1725	6.75"	1/2" x 1.88"	REV.
New SS935D ●	OPEN	1/2	115/208-230	7.60/3.70-3.80	1725	8.58"	1/2" x 1.88"	REV.
New SS936D ● [^]	OPEN	3/4	115/208-230	11.60/5.90-5.80	1725	10.55"	5/8" x 1.88"	REV.
GF2024	OPEN	1/4	115	5.40	1725	7.50"	1/2" x 1.50"	REV.
GF2034	OPEN	1/3	115	6.80	1725	7.80"	1/2" x 1.50"	REV.
GF2054	OPEN	1/2	115	8.00	1725	8.30"	1/2" x 1.50"	REV.
RB2024 ●	OPEN	1/4	115	5.00	1725	7.80"	1/2" x 1.50"	REV.
RB2034 ●	OPEN	1/3	115	6.00	1725	7.50"	1/2" x 1.50"	REV.
BF2054 ●	OPEN	1/2	115/208-230	8.20/4.10	1725	8.30	1/2" x 1.50"	REV.

([^]) 56 Frame

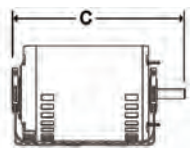

48 Frame - Single Speed

UIC MOTORS
Formerly Emerson Motors

Stock #	Encl.	HP	Volts	Amps.	RPM	"C" Dim.	Shaft	Rotation
New EM-840CV ●	OPEN	1/4	115	4.80	1725	9.40"	1/2" x 1.60"	REV.
New EM-841CV ●	OPEN	1/3	115	6.40	1725	9.90"	1/2" x 1.60"	REV.
New EM-1542C ●	OPEN	1/2	115	7.80	1725	9.90"	1/2" x 1.60"	REV.

56Z Frame - Two Speed

Stock #	Encl.	HP	Volts	Amps.	RPM	"C" Dim.	Shaft	Rotation
EM-5793C ●	OPEN	1/3	115	6.40	1725/1140	10.40"	1/2" x 1.50"	REV.
EM-5794C ●	OPEN	1/2	115	8.70	1725/1140	10.40"	1/2" x 1.50"	REV.
EM-5795C ●	OPEN	3/4	115	11.50	1725/1140	11.30"	1/2" x 1.50"	REV.

Features:

- Open Drip-Proof
- Class 'A' and 'B' Insulation
- Reversible Rotation
- Resilient Base
- 5/8" Diameter Shaft
- 40°C Ambient
- High Starting Torque
- Sleeve and Ball Bearings

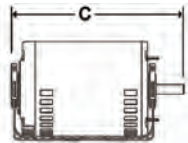

56 Frame



All Century Models



All US Motors Models



Formerly A.O. Smith Electrical Products Company



Formerly Emerson Motors

Stock #	Encl.	HP	Volts	Amps.	RPM	"C" Dim.	Rotation
C455	O.D.P.	1/3	115 / 208-230	6.60 / 3.00 - 3.30	1725	11.10"	REV.
C403 ●	O.D.P.	1/3	115 / 208-230	6.60 / 3.00 - 3.30	1725	11.10"	REV.
C607	O.D.P.	1/2	115 / 208-230	9.00 / 4.00 - 4.50	1725	11.10"	REV.
C412V1 ●	O.D.P.	1/2	115 / 208-230	9.00 / 4.00 - 4.50	1725	11.10"	REV.
C654	O.D.P.	3/4	115 / 208-230	5.40 - 5.50 / 11.00	1725	11.10"	REV.
C426V1 ●	O.D.P.	3/4	115 / 208-230	5.40 - 5.50 / 11.00	1725	11.10"	REV.
C692	O.D.P.	1	115 / 208-230	6.20 - 6.30 / 12.60	1725	11.40"	REV.
C523V1 ●	O.D.P.	1	115 / 208-230	6.20 - 6.30 / 12.60	1725	11.90"	REV.
C621 ●	O.D.P.	1-1/2	115 / 208-230	7.80 - 7.50 / 15.00	1725	12.70"	REV.
D13CA2JH9 ●	O.D.P.	1/3	115 / 208-230	8.80 / 3.90 - 4.40	1725	9.80"	REV.
EM-1790 ●	O.D.P.	1/3	115 / 208-230	7.40 / 3.70	1725	9.30"	REV.
EM-1893 ●	O.D.P.	3/4	115 / 208-230	11.40 / 5.70	1725	10.80"	REV.
EM-3187C ●	O.D.P.	1	115 / 230	14.00 / 7.00	1725	11.80"	REV.
EM-4242 ●	O.D.P.	1-1/2	115 / 208-230	22.40 / 11.20	1725	12.80"	REV.

Cross Reference

	Rotom	Emerson	GE	Marathon	Fasco
C455	N/A	N/A	N/A	N/A	N/A
C403	S1120	180	C216	C216	D6082
C607	S1138	N/A	N/A	N/A	N/A
C412V1	S1146	1790	C1153	B317	D6084
C654	S1168	N/A	N/A	N/A	N/A
C426V1	S1174	1893	C1156	B319	D6086
C692	N/A	N/A	N/A	N/A	N/A
C523V1	S1199	3187C	C1158	C1159	D6088
C621	S1336	4242	C1160	C1160	D6090

(●) Ball Bearing





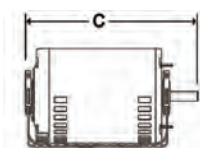

Features:

- Resilient Base and Rigid Base
- Reversible Rotation
- 5/8" Diameter Shaft
- Open Drip-Proof
- 40°C Ambient
- Ball Bearings



56 Frame



Stock #	HP	RPM	Volts	Amps.	Frame	Shaft Dia.	Base
H840	1/2	1800	460/200-230	1.00/1.9-2.0	56	5/8"	Resilient
H940V1	1/2	1800	575	0.70	56	5/8"	Resilient
H851V2	3/4	1800	460/200-230	1.50/2.8-3.0	56	5/8"	Resilient
H941L	3/4	1800	575	0.90	56	5/8"	Resilient
H842V1	1	3600	460/200-230	1.80/3.5-3.6	56H	5/8"	Resilient
H950	1	3600	575	1.50	56H	5/8"	Resilient
H852L	1	1800	460/200-230	2.00/3.7-4.0	56H	5/8"	Resilient
H942	1	1800	575	1.50	56H	5/8"	Resilient
H882	1	1800	460/200-230	2.00/3.7-4.0	56H	5/8"	Rigid
H883	1	1800	460/200-230	1.90/3.5-3.8	56HZ	7/8"	Rigid
H843V1	1-1/2	3600	460/200-230	2.30/4.7-4.6	56H	5/8"	Resilient
H944	1-1/2	3600	575	1.80	56H	5/8"	Resilient
H853V2	1-1/2	1800	460/200-230	2.80/5.0-5.6	56H	5/8"	Resilient
H943V1	1-1/2	1800	575	2.00	56	5/8"	Resilient
 UEH951	1-1/2	1800	575	2.00	56HZ	7/8"	Rigid
H884L	1-1/2	1800	460/200-230	2.80/5.0-5.6	56H	5/8"	Rigid
H885L	1-1/2	1800	460/200-230	2.80/5.0-5.6	56HZ	7/8"	Rigid
H951V1	1-1/2	1800	575	2.00	56HZ	7/8"	Rigid
H844	2	3600	460/200-230	2.90/6.0-5.8	56H	5/8"	Resilient
H952	2	3600	575	2.40	56H	5/8"	Resilient
H854	2	1800	460/200-230	3.00/6.6-7.0	56HZ	7/8"	Resilient
 UEH886	2	1800	460/200-230	7.60-7.8/3.9	56HZ	7/8"	Rigid
 UEH953	2	1800	575	2.70	56HZ	7/8"	Rigid
H845	3	3600	460/200-230	4.30/9.0-8.6	56HZ	7/8"	Resilient
H954	3	3600	575	3.60	56HZ	7/8"	Resilient
H980L *	3	1800	208-230/460	9.00-9.0/4.5	56Y	7/8"	Rigid
H855L	3	1800	460/200-230	4.40/9.0-8.8	56HZ	7/8"	Rigid
 UEH887	3	1800	460/200-230	4.60/9.0-9.2	56HZ	7/8"	Rigid
 UEH955	3	1800	575	3.40	56HZ	7/8"	Rigid
H847	5	3600	460/200-230	6.60/13.4-13.2	56HZ	7/8"	Rigid
H956	5	3600	575	5.40	56HZ	7/8"	Rigid
H979L *	5	1800	208-230/460	15.00/7.40	56Y	7/8"	Rigid

Features:

- Open Drip-Proof
- Rigid Base
- Class ‘F’ Insulation - Class ‘B’ Rise at Service Factor
- Reversible Rotation
- 1.15 Service Factor
- F-1 Assembly
- Aluminum End-Shields with Steel Inserts
- Light Weight Rolled Steel Frame
- Suitable for use with Inverters (VFD)
- Double Shielded Bearings (140 - 280 Frame)
- Lifting Provisions (210 Frame & Up)
- Regreasable Bearings (180 Frame & Up)
- Ball Bearings



42/36 Month Warranty *

Three Phase

Stock #	HP	Volts	Amps.	RPM	Frame	Efficiency %
D1P2D	1	208-230 / 460	3.20 / 1.50	1800	143T	85.5
D32P2D	1-1/2	208-230 / 460	4.40 / 2.10	1800	145T	86.5
D2P2D	2	208-230 / 460	5.90 / 2.80	1800	145T	86.5
D3P2D	3	208-230 / 460	8.40 - 7.80 / 3.90	1800	182T	89.5
D5P2D	5	208-230 / 460	13.80 - 13.00 / 6.50	1800	184T	89.5
D7P2D	7-1/2	208-230 / 460	20.20 - 18.50 / 9.30	1800	213T	91.0
D10P2D	10	208-230 / 460	26.30 - 23.80 / 11.90	1800	215T	91.7
D15P2D	15	208-230 / 460	40.00 - 37.00 / 18.30	1800	254T	93.0
D20P2D	20	208-230 / 460	54.00 - 49.00 / 24.40	1800	256T	93.0
D25P2D	25	208-230 / 460	64.00 - 58.00 / 29.00	1800	284T	93.6
D30P2D	30	208-230 / 460	77.00 - 69.00 / 34.00	1800	286T	94.1
D1P2G	1	575	1.30	1800	143T	85.5
D32P2G	1-1/2	575	1.70	1800	145T	86.5
D2P2G	2	575	2.20	1800	145T	86.5
D3P2G	3	575	3.20	1800	182T	89.5
D5P2G	5	575	5.20	1800	184T	89.5
D7P2G	7-1/2	575	7.20	1800	213T	91.0
D10P2G	10	575	9.80	1800	215T	91.7
D15P2G	15	575	14.80	1800	254T	93.0
D20P2G	20	575	19.20	1800	256T	93.0
D25P2G	25	575	23.00	1800	284T	94.1
D30P2G	30	575	27.70	1800	286T	94.1

(* Note: Warranty Period is 42 Months from Date of Manufacture or 36 Months from Date of Installation on Sine Wave Power or 30 Months from Date of Manufacture or 24 Months from Date of Installation on VFD Power, whichever occurs first.

Three Phase Motors Aluminum Frame



www.uem.ca

New Product

Features:

- Aluminum Construction
- Totally Enclosed Fan Cooled
- Continuous Duty
- Class 'B' Insulation
- Removable Bolt-on Feet
- Reversible
- 40°C Ambient
- UL Listed & CSA Approved
- 3 Positions for Feet Allow for F-1, F-2, F-0 Conduit Box Location
- Inverter Duty 10:1 V.T. / 2:1 C.T.
- Ball Bearings
- 1.15 S.F.

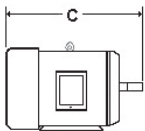

56 & 56HZ Frame

OMNiDRIVE

Stock #	HP	Volts	Amps.	"C"	Shaft (Dia.)	Frame
New WA631	1/3	208-230 / 460	1.26 - 1.14 / 0.57	12.67"	5/8"	56
New WA611	1/3	575	0.46	12.67"	5/8"	56
New WA681	1/3	208-230 / 460	1.43 - 1.30 / 0.65	12.67"	5/8"	56
New WA661	1/3	575	0.52	12.67"	5/8"	56
New WA632	1/2	208-230 / 460	1.82 - 1.64 / 0.82	12.67"	5/8"	56
New WA612	1/2	575	0.66	12.67"	5/8"	56
New WA682	1/2	208-230 / 460	2.12 - 1.92 / 0.96	12.67"	5/8"	56
New WA662	1/2	575	0.77	12.67"	5/8"	56
New WA633	3/4	208-230 / 460	2.59 - 2.34 / 1.17	12.67"	5/8"	56
New WA613	3/4	575	0.94	12.67"	5/8"	56
New WA683	3/4	208-230 / 460	2.94 - 2.66 / 1.33	12.67"	5/8"	56
New WA663	3/4	575	1.06	12.67"	5/8"	56
New WA634	1	208-230 / 460	3.24 - 2.92 / 1.46	13.66"	5/8"	56H
New WA614	1	575	1.17	13.66"	5/8"	56H
New WA684	1	208-230 / 460	3.84 - 3.48 / 1.74	13.66"	5/8"	56H
New WA664	1	575	1.39	13.66"	5/8"	56H
New TA624	1	208-230 / 460	3.24 - 2.92 / 1.46	14.02"	7/8"	56HZ
New TA604	1	575	1.17	14.02"	7/8"	56HZ
New TA674	1	208-230 / 460	3.84 - 3.48 / 1.74	14.02"	7/8"	56HZ
New TA654	1	575	1.39	14.02"	7/8"	56HZ

Features:

- Aluminum Construction
- Totally Enclosed Fan Cooled
- Continuous Duty
- Class 'B' Insulation
- Removable Bolt-on Feet
- Reversible
- 40°C Ambient
- UL Listed & CSA Approved
- 3 Positions for Feet Allow for F-1, F-2, F-0 Conduit Box Location
- Inverter Duty 10:1 V.T. / 2:1 C.T.
- Ball Bearings
- 1.15 S.F.

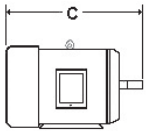

56 & 56HZ Frame

OMNIDRIVE®

Stock #	HP	Volts	Amps.	"C"	Shaft (Dia.)	Frame
New WA635	1-1/2	208-230/460	4.71 - 4.26 / 2.13	13.66"	5/8"	56H
New WA615	1-1/2	575	1.70	13.66"	5/8"	56H
New WA685	1-1/2	208-230/460	5.28 - 4.78 / 2.39	13.66"	5/8"	56H
New WA665	1-1/2	575	1.91	13.66"	5/8"	56H
New TA625	1-1/2	208-230/460	4.71 - 4.26 / 2.13	14.02"	7/8"	56HZ
New TA605	1-1/2	575	1.70	14.02"	7/8"	56HZ
New TA675	1-1/2	208-230/460	5.28 - 4.78 / 2.39	14.02"	7/8"	56HZ
New TA655	1-1/2	575	1.91	14.02"	7/8"	56HZ
New WA636	2	208-230/460	6.02 - 5.44 / 2.72	13.66"	5/8"	56H
New WA616	2	575	2.18	13.66"	5/8"	56H
New WA686	2	208-230/460	6.73 - 6.08 / 3.04	13.66"	5/8"	56H
New WA666	2	575	2.43	13.66"	5/8"	56H
New TA626	2	208-230/460	6.02 - 5.44 / 2.72	14.02"	7/8"	56HZ
New TA606	2	575	2.18	14.02"	7/8"	56HZ
New TA676	2	208-230/460	6.73 - 6.08 / 3.04	14.02"	7/8"	56HZ
New TA656	2	575	2.43	14.02"	7/8"	56HZ
New WA637	3	208-230/460	8.76 - 7.92 / 3.96	13.66"	5/8"	56H
New WA617	3	575	3.17	13.66"	5/8"	56H
New TA627	3	208-230/460	8.70 - 7.96 / 3.96	14.02"	7/8"	56HZ
New TA607	3	575	3.17	14.02"	7/8"	56HZ

Three Phase Motors Aluminum Frame



www.uem.ca

New Product

Features:

- Aluminum Construction
- Totally Enclosed Fan Cooled
- Continuous Duty
- Class 'B' Insulation
- Removable Bolt-on Feet
- Reversible
- 40°C Ambient
- UL Listed & CSA Approved
- 3 Positions for Feet Allow for F-1, F-2, F-0 Conduit Box Location
- Inverter Duty 10:1 V.T. / 2:1 C.T.
- Ball Bearings
- 1.15 S.F.

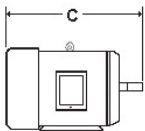

56C & 56HCZ Frame

OMNIDRIVE®

Stock #	HP	Volts	Amps.	"C"	Shaft (Dia.)	Frame
New WA631C	1/3	208-230 / 460	1.26 - 1.14 / 0.57	12.67"	5/8"	56C
New WA611C	1/3	575	0.46	12.67"	5/8"	56C
New WA681C	1/3	208-230 / 460	1.43 - 1.30 / 0.65	12.67"	5/8"	56C
New WA661C	1/3	575	0.52	12.67"	5/8"	56C
New WA632C	1/2	208-230 / 460	1.82 - 1.64 / 0.82	12.67"	5/8"	56C
New WA612C	1/2	575	0.66	12.67"	5/8"	56C
New WA682C	1/2	208-230 / 460	2.12 - 1.92 / 0.96	12.67"	5/8"	56C
New WA662C	1/2	575	0.77	12.67"	5/8"	56C
New WA633C	3/4	208-230 / 460	2.59 - 2.34 / 1.17	12.67"	5/8"	56C
New WA613C	3/4	575	0.94	12.67"	5/8"	56C
New WA683C	3/4	208-230 / 460	2.94 - 2.66 / 1.33	12.67"	5/8"	56C
New WA663C	3/4	575	1.06	12.67"	5/8"	56C
New WA634C	1	208-230 / 460	3.24 - 2.92 / 1.46	13.66"	5/8"	56HC
New WA614C	1	575	1.17	13.66"	5/8"	56HC
New WA684C	1	208-230 / 460	3.84 - 3.48 / 1.74	13.66"	5/8"	56HC
New WA664C	1	575	1.39	13.66"	5/8"	56HC
New TA624C	1	208-230 / 460	3.24 - 2.92 / 1.46	14.02"	7/8"	56HCZ
New TA604C	1	575	1.17	14.02"	7/8"	56HCZ
New TA674C	1	208-230 / 460	3.84 - 3.48 / 1.74	14.02"	7/8"	56HCZ
New TA654C	1	575	1.39	14.02"	7/8"	56HCZ

Features:

- Aluminum Construction
- Totally Enclosed Fan Cooled
- Continuous Duty
- Class 'B' Insulation
- Removable Bolt-on Feet
- Reversible
- 40°C Ambient
- UL Listed & CSA Approved
- 3 Positions for Feet Allow for F-1, F-2, F-0 Conduit Box Location
- Inverter Duty 10:1 V.T. / 2:1 C.T.
- Ball Bearings
- 1.15 S.F.

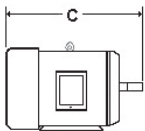

56C & 56HCZ Frame

OMNiDRIVE®

Stock #	HP	Volts	Amps.	"C"	Shaft (Dia.)	Frame
New WA635C	1-1/2	208-230/460	4.71 - 4.26 / 2.13	13.66"	5/8"	56HC
New WA615C	1-1/2	575	1.70	13.66"	5/8"	56HC
New WA685C	1-1/2	208-230/460	5.28 - 4.78 / 2.39	13.66"	5/8"	56HC
New WA665C	1-1/2	575	1.91	13.66"	5/8"	56HC
New TA625C	1-1/2	208-230/460	4.71 - 4.26 / 2.13	14.02"	7/8"	56HCZ
New TA605C	1-1/2	575	1.70	14.02"	7/8"	56HCZ
New TA675C	1-1/2	208-230/460	5.28 - 4.78 / 2.39	14.02"	7/8"	56HCZ
New TA655C	1-1/2	575	1.91	14.02"	7/8"	56HCZ
New WA636C	2	208-230/460	6.02 - 5.44 / 2.72	13.66"	5/8"	56HC
New WA616C	2	575	2.18	13.66"	5/8"	56HC
New WA686C	2	208-230/460	6.73 - 6.08 / 3.04	13.66"	5/8"	56HC
New WA666C	2	575	2.43	13.66"	5/8"	56HC
New TA626C	2	208-230/460	6.02 - 5.44 / 2.72	14.02"	7/8"	56HCZ
New TA606C	2	575	2.18	14.02"	7/8"	56HCZ
New TA676C	2	208-230/460	6.73 - 6.08 / 3.04	14.02"	7/8"	56HCZ
New TA656C	2	575	2.43	14.02"	7/8"	56HCZ
New WA637C	3	208-230/460	8.76 - 7.92 / 3.96	13.66"	5/8"	56HC
New WA617C	3	575	3.17	13.66"	5/8"	56HC
New TA627C	3	208-230/460	8.70 - 7.96 / 3.96	14.02"	7/8"	56HCZ
New TA607C	3	575	3.17	14.02"	7/8"	56HCZ



Features:

- Totally Enclosed Construction
- Cast Iron Construction
- Three Year Warranty
- Dual Mounting Holes
- Cast Iron Gasketed Conduit Box
- Double Lip Seal on Both Ends
- Class 'F' Insulation - Class 'B' Temp. Rise
- NEMA MG 1, EEMAC M1-6, CSA C390
- Double Sealed 'ZZ' Bearings up to (215T Frame)
- Standard (Non-Metric) Hardware
- F-2 Field Convertible
- Conduit Box can be Rotated 90 Degrees
- Ground Lug in Conduit Box
- Rust Preventative Treated Steel Fan Cover
- VPI Insulation System
- 'C' Face Kits Available
- 20:1 V.T. / 10:1 C.T.
- Inverter Duty
- Regreasable Bearings (254T Frame & Up)
- Oversized Ball Bearings



All Models



Three Phase

Stock #	HP	Volts	Amps.	RPM	Frame	Efficiency %	C Face Kit
TCP657 ●	3	575	3.10	1800	182T	87.5	CFP18
TCP658 ●	5	575	5.20	1800	184T	87.5	CFP18
TCP659 ●	7.5	575	7.50	1800	213T	89.5	CFP21
TCP65A ●	10	575	10.00	1800	215T	89.5	CFP21
TCP65B ●	15	575	14.90	1800	254T	91.0	CFP25
TCP65C ●	20	575	19.60	1800	256T	91.0	CFP25
TCP65D ●	25	575	23.60	1800	284T	92.4	CFP28
TCP65E ●	30	575	28.30	1800	286T	92.4	CFP28
TCP65F ●	40	575	37.00	1800	324T	93.0	CFP32
TCP65G ●	50	575	46.30	1800	326T	93.0	CFP32
TCP65H ●	60	575	53.60	1800	364T	95.0	CFP36
TCP65I ●	75	575	66.60	1800	365T	95.4	CFP36
TCP65J ●	100	575	90.00	1800	405T	95.4	CFP40
TCP65K ●	125	575	109.00	1800	444T	95.4	CFP44
TCP65L ●	150	575	130.00	1800	445T	95.8	CFP44
TCP65M ●	200	575	172.00	1800	447T	96.2	CFP44

Features:

- Open Drip-Proof
- Single Phase & Three Phase
- Mounting Bracket
- 1800 RPM
- Permanently Sealed Ball Bearings
- Replacements for OEM Motors such as Armstrong (A), Bell & Gossett (B) & Taco (T)

Type '2A' 4.67" B.C.D. fits # 2 Bearing Assembly
 Type '2B' 5.00" B.C.D. fits # 3 & 4 Bearing Assembly
 Type '2C' 5.875" B.C.D. fits # 5, 6 & 7 Bearing Assembly



Type 2A & 2B



Type 2C



Type 2C

Single Phase

OMNIDRIVE®

Stock #	HP	Volts	Amps.	Type	Bearing	Rotation	Replaces
SS1350	1/12	115	2.5	2A	Ball	CWSE	R1350
SS1355	1/6	115	3.8	2A	Ball	CWSE	----
SS1352	1/6	115	3.8	2B	Ball	CWSE	R1352
SS1354	1/4	115	4.6	2B	Ball	CWSE	R1354
SS1444	1/4	115	4.6	2C	Ball	CCWSE	R1444
SS1356	1/3	115	6.0	2B	Ball	CWSE	R1356
SS1446	1/3	115	6.0	2C	Ball	CCWSE	R1446
SS1459	1/2	115-208/230	5.7/3.0-2.9	2C	Ball	REV	R1459
SS1462	3/4	115-208/230	8.2/4.7-4.2	2C	Ball	REV	R1462
C245 ^	1	230/115	6.5/13.0	4	Ball	REV	R1463

(^) Round Body - No Bracket



Type 3



Type 4

Three Phase

Century®

Formerly A.O. Smith Electrical Products Company

Stock #	HP	Volts	Amps.	Type	Bearing	Rotation	Replaces
H1041L	1/2	208-230/460	1.8-2.0/1.0	3	Ball	REV.	R1368
H1046	1/2	575	0.9	3	Ball	REV.	R1369
H1042L	3/4	208-230/460	2.7-2.8/1.4	3	Ball	REV.	R1370
H1047	3/4	575	1.1	3	Ball	REV.	R1372
H982	3/4	208-230/460	2.5-2.6/1.3	4	Sleeve	REV.	(T)
H983	3/4	208-230/460	2.5-2.6/1.3	4	Sleeve	REV.	(A,B)
H1043L	1	208-230/460	3.4-3.4/1.7	3	Ball	REV.	R1371
H1048L	1	575	1.4	3	Ball	REV.	R1373
H984	1	208-230/460	3.4-3.4/1.7	4	Sleeve	REV.	(A)
H985L	1	208-230/460	3.4-3.4/1.7	4	Sleeve	REV.	(B)
H946L	1	208-230/460	3.7-3.6/1.8	4	Sleeve	REV.	(T)
H947L	1	575	1.4	4	Sleeve	REV.	(T)
H1044	1.5	208-230/460	5.7-5.6/2.8	3	Ball	REV.	R1374
H1049V1	1.5	575	2.1	3	Ball	REV.	R1375
H986	1.5	208-230/460	4.8-5.0/2.5	4	Sleeve	REV.	(A, B)
H987	2	208-230/460	6.3-6.4/3.2	4	Ball	REV.	(T)
H988	3	208-230/460	4.4/9.0-8.8	4	Ball	REV.	(T)

OPTIDRIVE E2 - Single Phase

Digital control for Single Phase motors - AC Variable Speed Drive 0.5-1.5 HP (115V & 240V Ratings)

The Optidrive E2 Single Phase is the world's first fully digital, fully packaged variable speed drive for controlling low power single phase motors. Designed to be cost effective and easy to use, the Optidrive E2 Single Phase is for use with PSC (Permanent Split Capacitor) or Shaded-Pole Single-Phase induction motors. Optidrive E2 Single Phase uses a revolutionary motor control strategy to achieve reliable intelligent starting of single phase motors. Optidrive E2 Single Phase has only 14 standard parameters to adjust in its basic form. The Optidrive's legendary ease of use ensures quick and easy drive commissioning. For the more advanced user the extended parameter set gives access to powerful additional functionality.

Typically used for direct-drive fans and blowers with PSC (permanent-split capacitor) and shaded pole motors on single-phase power. These are typically applications with a starting torque of between 50-100% of motor full load rated torque.



OPTIDRIVE E2 - Single Phase IP66/NEMA 4X Enclosure

Digital control for Single Phase motors - AC Variable Speed Drive 0.5-1.5 HP (115V & 240V Ratings)

All the same features & performance as above plus:

- Local potentiometer for speed control
- Drive FWD/OFF/REV switch - Programmable for Hand / Auto (Local / Remote) applications
- Built-In Disconnect - Provides the ability to isolate the motor for maintenance and servicing.



OPTIDRIVE E2 - Three Phase IP20 Enclosure

Ease of Use - AC Variable Speed Drive 0.5-15 HP (115V, 240V & 480V Ratings)

Rich in features the Optidrive E2 is the most commercially competitive Optidrive in the Optidrive family. Innovative and compact the Optidrive E2 range combines good looks with robustness, reliability and easy to use performance. The product is dedicated to low power applications where total costs are ultra-competitive, including: Competitive purchase price, Low installation costs, Low commissioning costs & Low technical support costs. Optidrive E2 has only 14 standard parameters to adjust in its basic form, thus Optidrive's legendary ease of use could not be easier or quicker to get started with.



OPTIDRIVE E2 - Three Phase IP66/NEMA 4X Enclosure

Ideal for washdown applications - AC Variable Speed Drive 0.5-10 HP (115V, 240V & 480V Ratings)

Expanding on the success of the Optidrive E2, IP20 and IP55/NEMA 12 products, the Optidrive E2 IP66/NEMA 4X is ideal for food and beverage as well as pharmaceutical applications. The IP66 / NEMA 4X enclosure is a cost-effective, washdown duty Optidrive for low power situations. Ready for high-pressure washdown, the IP66 / NEMA 4X can mount directly on your processing equipment.



OPTIDRIVE HVAC - Three Phase IP20 Enclosure

AC Variable Speed Drive 1-350 HP (240V, 480V & 600V Ratings)

Optidrive HVAC sets a new standard for dedicated fan & pump control.

Whilst retaining the ease of use traditionally associated with Invertek Drives, Optidrive HVAC has an innovative design, combined with robust performance to provide powerful flow control and reliability in a compact drive. Example savings based on a 45kW load using Optidrive HVAC compared to direct on-line control, an estimated 20% reduction in speed results in potential energy savings of 50%.

The Optidrive HVAC provides powerful and flexible control that is ideal for applications such as centrifugal pumps and fan units, where large and immediate energy savings can almost always be found.

575-600V
NOW
AVAILABLE



OPTIDRIVE HVAC - Three Phase IP55 & IP66 Enclosure

AC Variable Speed Drive 1-350 HP (240V, 480V & 600V Ratings)

All the same features & performance as the OPTIDRIVE HVAC IP20.

575-600V
NOW
AVAILABLE



OPTIDRIVE P2 - Three Phase IP20 Enclosure

AC Variable Speed Drive 1-350 HP (240V, 480V & 600V Ratings)

The all new Optidrive P2 provides world leading control for both standard induction motors and permanent magnet motors.

Open loop vector control of standard induction motors provides up to 200% torque from zero speed. Open and closed loop control of the latest generation of high efficiency PM motors. Closed loop encoder feedback capability for standard induction motors. Extensive I/O and communications interface capabilities ensure the drive can be integrated quickly and efficiently into a wide variety of control systems. A simple parameter structure and carefully selected factory settings ensure fast and easy commissioning..

575-600V
NOW
AVAILABLE



OPTIDRIVE P2 - Three Phase IP55 & IP66 Enclosure

AC Variable Speed Drive 1-350 HP (240V, 480V & 600V Ratings)

All the same features & performance as the OPTIDRIVE P2 IP20 Enclosure.

- IP55/NEMA 12 'Un-Switched'
- IP66/NEMA 4X 'Switched' includes:
 - Local potentiometer for speed control
 - Drive FWD/OFF/REV switch - Programmable for Hand / Auto (Local / Remote) applications
 - Built-In Disconnect - Provides the ability to isolate the motor for maintenance and servicing.

575-600V
NOW
AVAILABLE



MORE MOTOR KNOWLEDGE... MORE MOTOR EXPERIENCE... MORE MOTOR VARIETY... AT YOUR SERVICE

WE ALSO OFFER:

	UNIT BEARING MOTORS		MORE OEM REPLACEMENT MOTORS
	ECM REFRIGERATION MOTORS		MORE BLOWERS
	PM & SHUNT WOUND DC MOTORS		MORE 3.3" DIAMETER MOTORS
	COMPRESSOR DUTY MOTORS		MORE 4" DIAMETER MOTORS
	PUMP MOTORS		MORE 5" DIAMETER MOTORS
	GENERAL PURPOSE MOTORS (IHP)		MORE 48 FRAME MOTORS
	ELEVATOR DUTY MOTORS		MORE 56 FRAME MOTORS
	FARM DUTY MOTORS		MORE SKELETON MOTORS



INTEGRITY OF CATALOG: The information contained in this catalogue is for reference purposes only. We strive to ensure that the information is as accurate and current as possible. We are in no way responsible for any errors that may arise. We reserve the right to change specifications and other information included without prior notice. If you are concerned about the validity of the information on a certain product, please visit www.uem.ca and contact us.

DISCLAIMER: All content offered from or available in our catalogue are provided to you on an "as is" basis, without representations, warranties or conditions of any kind. You acknowledge and agree that any reliance by you on any information available in this catalogue shall be at your own risk.

All rights reserved. You may not produce, copy, modify or redistribute the design or layout of any Universal Electric Motors content without written permission.

It is important to note that Universal Electric Motors is not affiliated with any of the original equipment manufacturers or their brands which may be referred to herein. Other trade-marks featured in this catalogue are the property of their respective owners. No association between Universal Electric Motors and any trademark holder is expressed or implied. The names, descriptions, numbers and symbols featured throughout this catalogue are for cross reference purposes only.